

COMPARISON OF ENVIRONMENTAL AND BLAST RESPONSE

Test House - Blanford, Indiana
for
Peabody Coal Company
Indiana Division
Evansville, Indiana

DRAFT

January 28, 1988

Prepared by
Digital Vibration, Incorporated

Charles H. Dowding
Spencer W. Lucole

BACKGROUND, SUMMARY, AND SCOPE

Mining near the town of Blanford, Indiana for a number of years has led to an opportunity for Peabody Coal Company to study and compare environmental and blast effects. Such a comparison allows description of any blast effects relative to those caused by common environmental changes, which should be familiar to the public and provide a common experience.

The long term nature of the mining and the proximity of a number of residential structures allowed a critically close home to be instrumented for a sufficiently long time to draw significant conclusions. This home was chosen from existing housing stock and thus represents conditions typical of Blanford and rural Indiana.

GENESIS OF THE INVESTIGATION

In the spring of 1985 Peabody Coal Company began to negotiate with Digital Vibration, Inc. to develop a plan for a test house that would extend the work on a test house in southern Indiana that had been conducted by the United States Bureau of Mines between 1979 and 1982. The first phase of the study, a survey to establish initial conditions before instrumentation of the site and the

structures, uncovered probable causes for much of the existing cracking in the structure and concrete flat work and documented the structural support system and underlying rock and soil. A second and simultaneous phase involved instrumentation of the site and establishment of survey stations and benchmarks.

In the spring of 1986 instrumentation of the house to measure dynamic response was begun. A revolutionary system to simultaneously monitor both long term (environmental) and dynamic (blast) response remotely by telephone was site tested during the summer and became fully operational at the end of August, 1986. The test house was then continuously monitored until May, 1987.

SPECIAL TALENTS OF DIGITAL VIBRATION, INC.

Digital Vibration, Inc. (DVI) is uniquely qualified to conduct this study for Peabody Coal Company (PCC) and the residents of Indiana. The company combines the talents of S.W. Lucole, former Vice-President of one of the first vibration monitoring firms in the United States, Professor C.H. Dowding, author of BLAST VIBRATION MONITORING AND CONTROL, and Computer Analytics Corporation, developers of computerized monitoring equipment.

S.W. Lucole has developed vibration systems to monitor military explosions and many of the first systems to continuously monitor blasting vibrations. During his over 30 years of blast vibration experience he has consulted for

many of the large mining firms and environmental agencies in the Midwest and the United States.

C.H. Dowding was instrumental in developing techniques to account for frequency of vibration in blasting controls and was one of the authors of two of the most recent U.S. Bureau of Mines reports on blast vibration response of residential structures. Since writing his Ph. D. thesis on blasting vibrations nearly 20 years ago, he has written, in addition to his book, over 30 articles on vibration related phenomena.

Computer Analytics Corporation has designed, built and maintains other computer tele-monitoring systems for Commonwealth Edison Co. of Illinois to monitor weather conditions near power generating stations and Northern Indiana Public Service Co. to monitor stack emissions.

RESEARCH GOALS

Of primary importance in this study is the measurement of response of a house typical of rural Indiana. While the U.S. Bureau of Mines had spent an enormous sum of money and tens of man-years of effort in their recent investigation of blast effects, concern was expressed that conditions particular to Blanford were not addressed. One of the conditions was that of mature construction. Therefore the home chosen by PCC for a test house was located in and constructed with techniques typical for Blanford.

It was important to determine what had caused existing cracks in this test house. Therefore the first phase of work focused on the determination of causes of existing cracks and their relation to structural support systems. It was found that many construction irregularities and techniques not found in architectural standards or in U.S.D.A. recommendations for rural housing lead to abnormal cracking. Subsurface conditions were defined by borings in order to determine if special conditions existed beneath the test house. Four deep borings did not penetrate voids, which indicated that the house was not located over abandoned workings. Two soil borings indicated a 10 to 11 foot soil layer above rock.

Another primary goal was the comparison of environmental and blast effects. An environmental effect is one that is caused naturally by forces normally at work in the environment. Such forces are those produced by changes in weather such as temperature and humidity, changes in the subsurface such as those produced by rising water tables and frost induced heave, or household activities such as door slamming. A blast effect is that produced by blast noise and/or vibration. The effect monitored in this study was deformation, a change in crack opening, or the appearance of a hair sized crack.

The subsurface near the test house was instrumented to measure the environmental effects of changes in the water table and expansion/contraction of the soil. The measure-

ment system for expansion/contraction was also used as surveying bench marks for elevation surveys to monitor changes in house elevation.

Comparison of environmental and blast induced deformation of the wall covering materials was facilitated by the use of proximity gauges that were specially configured to measure both long-term, static (environmental) and dynamic (blast) deformation. These six gauges were affixed to walls in order to compare movements produced by changes in environmental factors and blasting. Other static observations were made with mechanical micrometers to confirm measurements made with the proximity gauges.

Also of great importance was the observation of cracks. A systematic method of crack observation before and after critical blasts was developed through grid subdivision of critical wall sections.

SUMMARY OF FINDINGS

The test house was found to be unique, owner rennovated, and of non-standard construction. This condition indicates that the test house is representative of many homes in Blanford. At the same time it is significantly different from the U.S. Bureau of Mines test house which was recently built with standard techniques. The condition of many of this specific test home's severely cracked sections was directly attributable to non-standard construction or significant environmental effects.

Crack inspection immediately before and after significant blasts showed no blast induced cracking in test wall sections up to peak particle velocities of 0.76 inches per second. No blast induced cracks were observed, as the project was terminated due to loss of funding before inspections could be made at higher levels of particle velocity.

Environmental effects are many times greater than those caused by blasting, which is the same conclusion found by the U.S. Bureau of Mines as reported in RI 8896, EFFECTS OF REPEATED BLASTING ON A WOOD FRAME HOUSE (Stagg et al., 1983).

SCOPE OF REPORT

The second chapter presents the setting and describes instrument locations. Appendix I presents technical details of the instruments and observation procedures employed in the test house. These instruments are grouped in the following four sections in the appendix: environmental instrumentation, response instrumentation, Tele-Blast monitoring and data management system, and visual crack observation.

The Third Chapter presents the environmental response of the test house, garage, sidewalls, and foundation soil over the life of the project. A portion of the environmental response measurements began in September of 1985, while the remote monitoring of dynamic displacements did not begin

until September of 1986. The measurements ceased in May of 1987. The chapter focuses upon the effects of weather on the non-vibration response of the test house.

Chapter Four describes the blasting environment in order to develop the background for Chapter Five, the comparison of environmental and blasting displacement response. The special displacement gauges and computerized data management system allowed measurement of both the long-term weather effects as well as the transient blast vibration effects at the same location with the same instrument.

Finally, Chapter Six is a summary of the visual crack observation, wherein no blast induced cracking was observed at the sections under observation.

This report is a summary of the two volume "Raw Data Report" (Dowding, 1988) that is bound separately. Volume I contains tabular information while Volume II contains the graphical information. All of the data presented in comparative form herein can be found in the "Raw Data Report" in its initial, non-synthesized state.

CHAPTER 2

SETTING AND INSTRUMENT SYSTEM

The test house was located some 1,000 feet from the Universal Mine at Blanford, Indiana. As such, it was the closest house to blasting during the study; a sense of the proximity can be gained from the photographs of the house and mining in Figure 2-1.

INITIAL CONDITION

The exterior of the test house has been covered with white aluminum siding and a brick half wall, which provides a common finish for three distinct building sections. These three sections become obvious when the basement elevations are included in the elevation view diagram of the north side of the structure shown in Figure 2-2. The original, middle portion is flanked by the eastern (shallowly founded) and western (full basement) additions.

This house is representative of conditions associated with owner renovation in a locality without a strong tradition of adherence to building codes. For instance, the brick veneer half-wall is founded on the separate, shallow footing shown in Figure 2-2, which was built after construction of the additions. This unattached foundation for the brick is founded above the depth of frost penetra-



a) North Elevation View



b) View toward South Showing Mine

FIGURE 2-1

PHOTOGRAPHS OF THE TEST HOUSE SHOWING VARIATION
IN HEIGHT AND PROXIMITY TO MINING

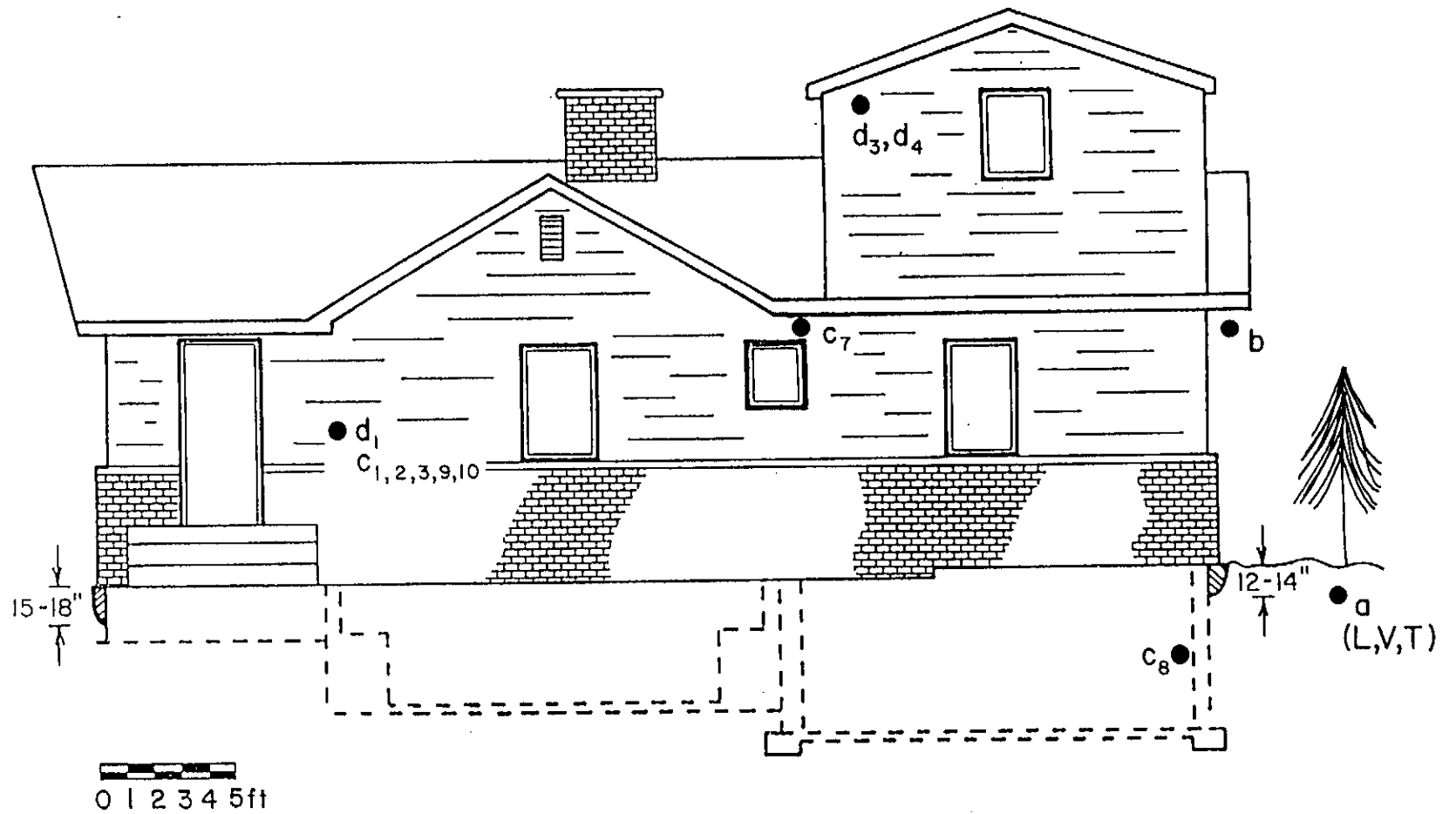

FIGURE 2-2

ELEVATION VIEW OF TEST HOUSE WITH BASEMENTS TO SHOW
 VELOCITY (d & a) AND DISPLACEMENT (c) TRANSDUCER LOCATIONS

tion and has settled differentially along the house because of different soil conditions beside the three house sections. The greatest differential settlement occurred adjacent to the western or right addition where there is the greatest likelihood of insufficient compaction of over excavated soil. Other non-standard conditions were found in interior framing as well. For instance, wall stud spacing is 24 inches instead of the standard 18 inches.

INSTRUMENT AND VISUAL CRACK OBSERVATION SYSTEMS

Monitoring of environmental and blast effects involved more than just instruments. It included surveying, vibration triggered monitoring, continuous surveillance, remote triggering, comparison of measured values, and systematic crack observation. This over-all system involved the following quantitative observations:

- 32 Survey points
- 4 Soil movement anchors
- 2 Water table monitors
- 6 Static crack deformation gauges
- 6 Dynamic (blast) and environmental crack deformation gauges
- 8 Velocity and airblast transducers
- 5 Weather monitoring gauges
- 7 Crack observation sections
- 2 Telephone connected computers (the Tele-Blast system)

Technical details of these instruments are described in Appendix I. The fourteen dynamic crack deformation gauges and velocity and airblast transducers were continuously and remotely monitored by the computerized Tele-Blast system to record vibration motion and crack deformation from any blasting, natural phenomena, or normal household activity.

This computerized system is an advanced version of that employed by the U.S. Bureau of Mines for its test house (Stagg et al., 1984). The continuous monitoring of house response that triggers upon either ground or wall motion allows sensing of both blast and environmental response such as that to thunder as well as response to human activity such as door slamming. Remote triggering allows sensing of displacements from Chicago in order to monitor weather induced effects.

Most importantly, use of the same displacement gauges to measure blast and environmentally induced deformation allowed exact comparison between the two effects at the same location. This is the first time such a comparison has been made over a period of eight months, and as such the computerized monitoring system significantly advances the state-of-the-art of structural response monitoring.

An orderly process of crack observation is as important as the measurement of wall motions and deformation that is automatically accomplished through the Tele-Blast system. The procedure must allow distinction between environmental and single event blast induced cracking. Such distinction is possible only with visual inspection of critical wall surfaces immediately before and immediately after a blast. This inspection must be conducted for any significant increase in ground motion at the test house.

The pre-blast inspection was necessary to isolate any possible environmentally induced cracks that may have

developed between crack inspections. Since threshold blast cracks are similar to those caused by the normal aging process (Stagg, et al., 1983), it was important that the two types of cracks not be confused. If an environmental crack had appeared between inspections, the pre-blast inspection would identify it and exclude it from cracking attributable to the specific blast in question.

INSTRUMENT LOCATION

Arrangement of the predominantly exterior environmental instrumentation is shown in Figure 2-3. Temperature and humidity gauges were located in the west back yard for the exterior and on the fireplace for the interior, and the wind velocity gauge was located on the TV antenna that is attached to the north wall of the house. Ground motion transducers were buried in the ground and the airblast over-pressure transducer was hung under the eaves at the southwest corner of the house. Water table monitors were placed in the soil at the southwest and northeast diagonal corners of the house. Soil movement anchors were placed around the house and the garage to monitor soil shrinkage/swelling. These anchors also served as bench marks for the elevation surveys of the house and garage structures, lower course of the brick veneer, and concrete driveway.

Interior response instrumentation was placed throughout the house as shown in Figure 2-4. As shown in the key,

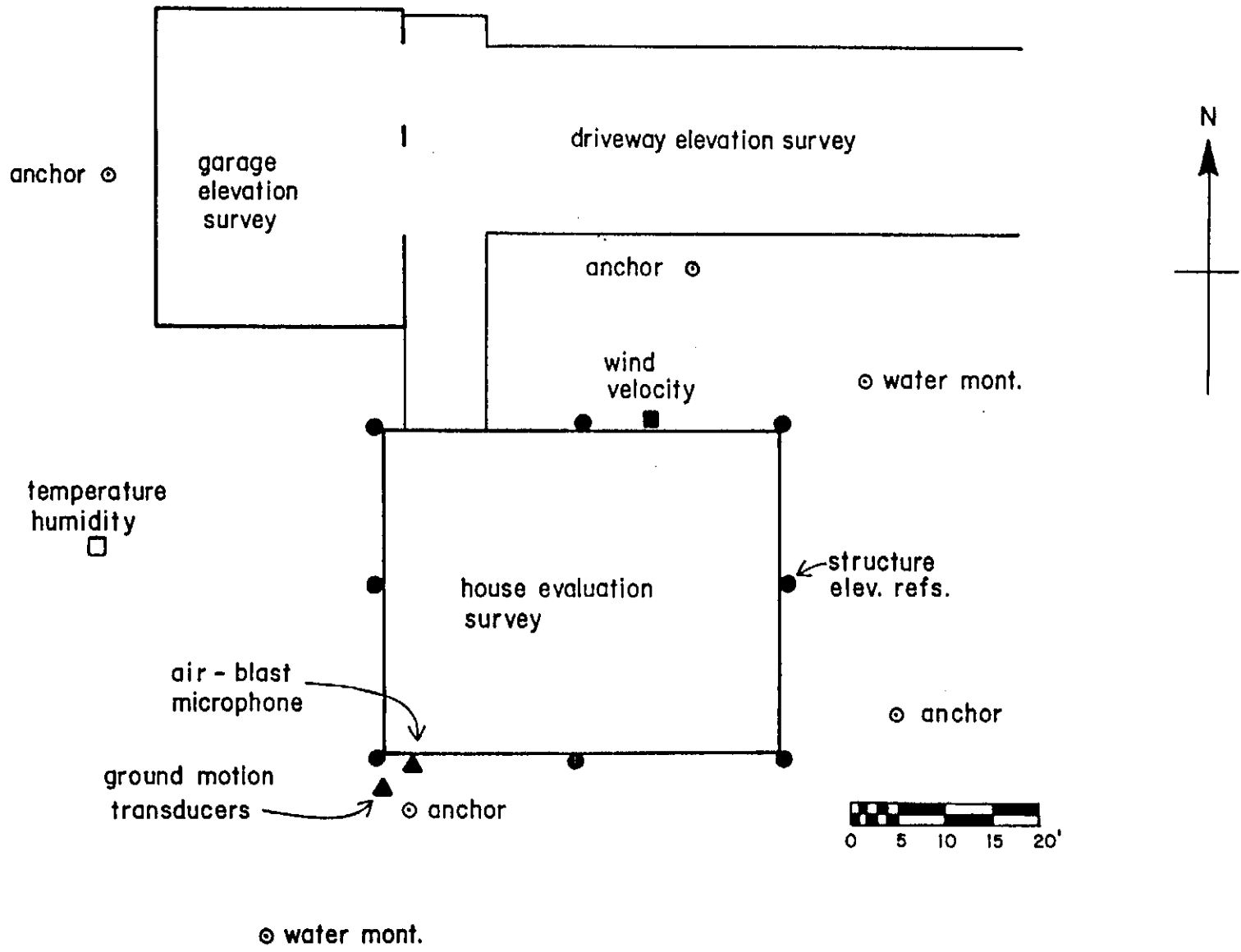

FIGURE 2-3

LOCATION OF EXTERIOR MEASUREMENTS AND INSTRUMENTATION

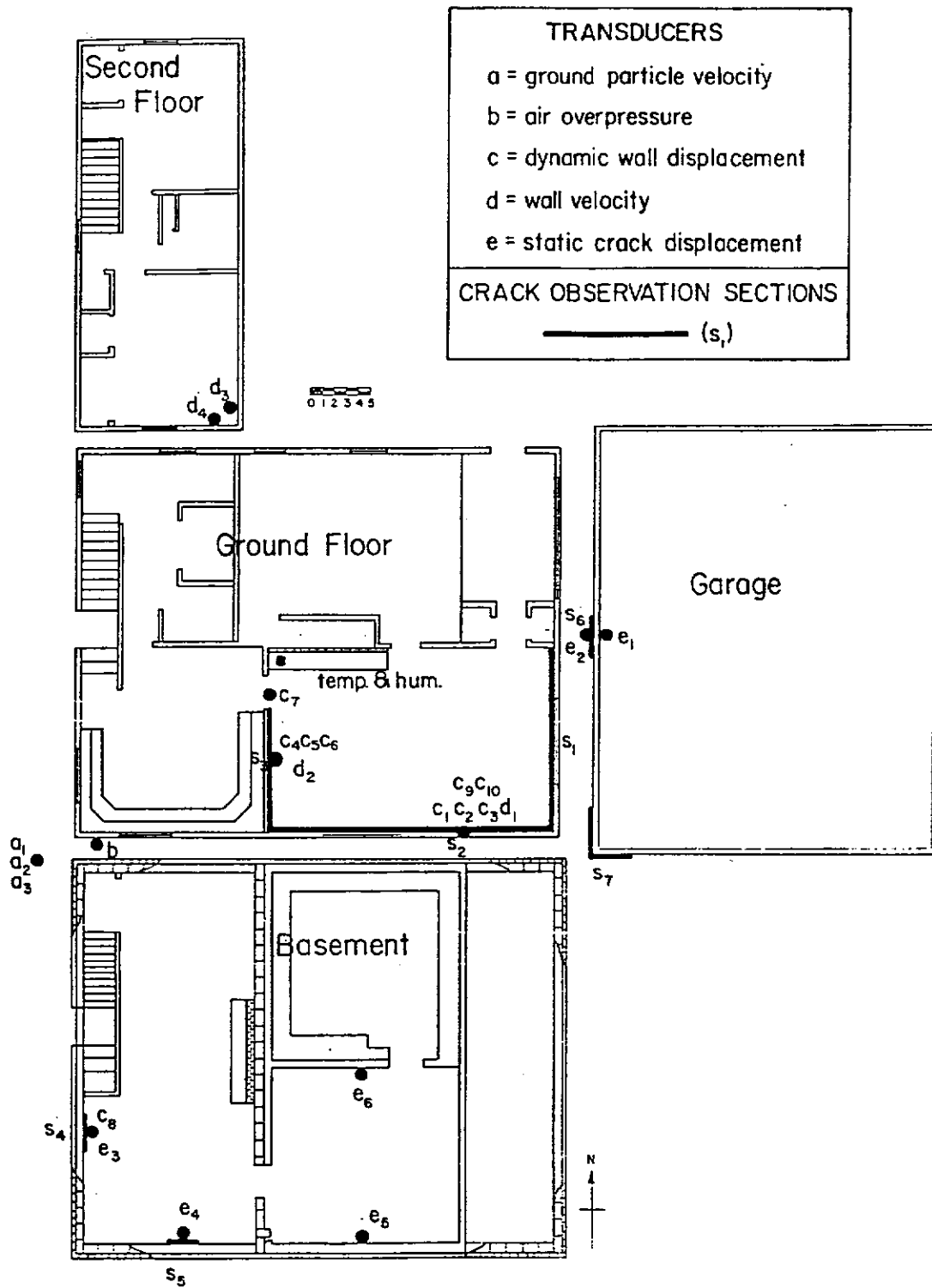

FIGURE 2-4

MEASUREMENT LOCATIONS
 VELOCITY, DISPLACEMENT, AND CRACK OBSERVATION

this instrumentation serves four major functions: (1) monitoring the excitation ground motions (a_1 - a_2) and air overpressure (b), (2) monitoring the dynamic (blast) and environmentally induced crack/wall displacement (c_1 - c_6) and velocity (d_1 - d_4) of the walls and superstructure as they responded to the excitation, (3) monitoring the long-term crack displacement (e_1 - e_6) on walls, and (4) visually inspecting for crack appearance (s_1 - s_7). The special properties of the dynamic crack displacement gauges also allows them to measure environmental or weather induced displacements.

Location and orientation information for each velocity transducer (d_1 - d_4 or H_1 - H_4) is presented in Table 2-1 by date along with similar information for the other transducers. Positions and orientation for the wall response velocity transducers were chosen to measure both superstructure response (d_3 and d_4) and wall membrane response (d_1 and d_2). As can be seen in Figures 2-2 and 2-4 and Table 2-1, d_1 and d_2 are located at mid-wall height and oriented north/south and east/west, which indicates horizontality and perpendicularity to walls oriented eastwest and northsouth, respectively. Comparison of Table 2-1 with Figure 2-4 shows d_1 and d_4 to be oriented north/south on a wall oriented east/west with d_2 and d_3 oriented in an east/west direction

As with the velocity gauges, location and orientation of the dynamic displacement transducers are presented on Figure

TABLE 2-1
TRANSDUCER LOCATION LOG

Location Fig 2-6	Tele-Blast	Start Date	Stop Date	Height (in)	Orientation
a ₁	L (N/S)	07/09/86		-12	N-S
a ₂	T (E/W)	"		-12	E-W
a ₃	V	"		-12	Vert
b	air	07/09/86		96	Up
c ₁	D ₁ *	07/09/86	01/06/87	mid wall	180°**
c ₂	D ₂ *	"		"	135°
c ₃	D ₃ *	"	01/06/87	"	90°
c ₄	D ₄ *	"	07/21/86	"	180°
c ₅	D ₅ *	"	09/12/86	"	135°
c ₆	D ₆ *	"		"	90°
c ₇	D ₄	07/21/86		top	90°
c ₈	D ₅	09/12/86		mid wall	180°
c ₉	D ₁	01/06/87		mid wall	180°
c ₁₀	D ₃	01/06/87		mid wall	90°
d ₁	H ₁	07/09/86		mid wall	N-S
d ₂	H ₂	"		mid wall	E-W
d ₃	H ₃	"		top	E-W
d ₄	H ₄	"		top	N-S
e ₁		07/21/86			***
e ₂		"			***
e ₃		"			***
e ₄		"			***
e ₅		"			***
e ₆		"			***

-
- * Removed for enhancement on 07/25/86 and replaced on 08/21/86. System became operational on 08/21/87 at 17:04.
- ** Transducers are placed on a vertical surface. Orientations given with respect to 0° = 12 o'clock and 180° = 6 o'clock.
- *** All transducers are placed on a vertical surface and oriented perpendicular to pre-existing crack.

2-4 and in Table 2-1. These gauges always measure displacements in the plane of the wall, but have various orientations on the wall. Therefore, the orientation column in Table 2-1 presents an angular orientation with 12 o'clock representing 0 degrees. The same six transducers were moved during the course of the research to monitor response at ten different locations. This movement required recording the start and stop dates for the transducer location number shown in Figure 2-4.

ENVIRONMENTAL RESPONSE OVER TIME

Past work (Dowding, 1985; Stagg et al., 1984) has shown that the many environmental factors that produce long-term deformation can be separated into the following three broad classes:

- * Foundation movement
- * Chemical-thermal movement in building materials
- * Structural movements from overloading, creep, etc.

This chapter describes the measurement of responses to these factors at the test house described in the last chapter. These responses are usually so slow that it is difficult to notice their day to day change and the monitoring period had to extend to one year and beyond. Foundation movement was measured by mechanical gauges and optical surveying, while chemically and thermally induced movement was measured by the inductance gauge described in Appendix I. These movements were then correlated in time with changes in environment such as weather and the level of the water table.

WATER TABLE EFFECTS

As shown in Figure 3-1, the water table at the test house fluctuates seasonally some 5 feet with a winter high

FIGURE 3-1

SOIL DEFORMATION vs. WATER TABLE

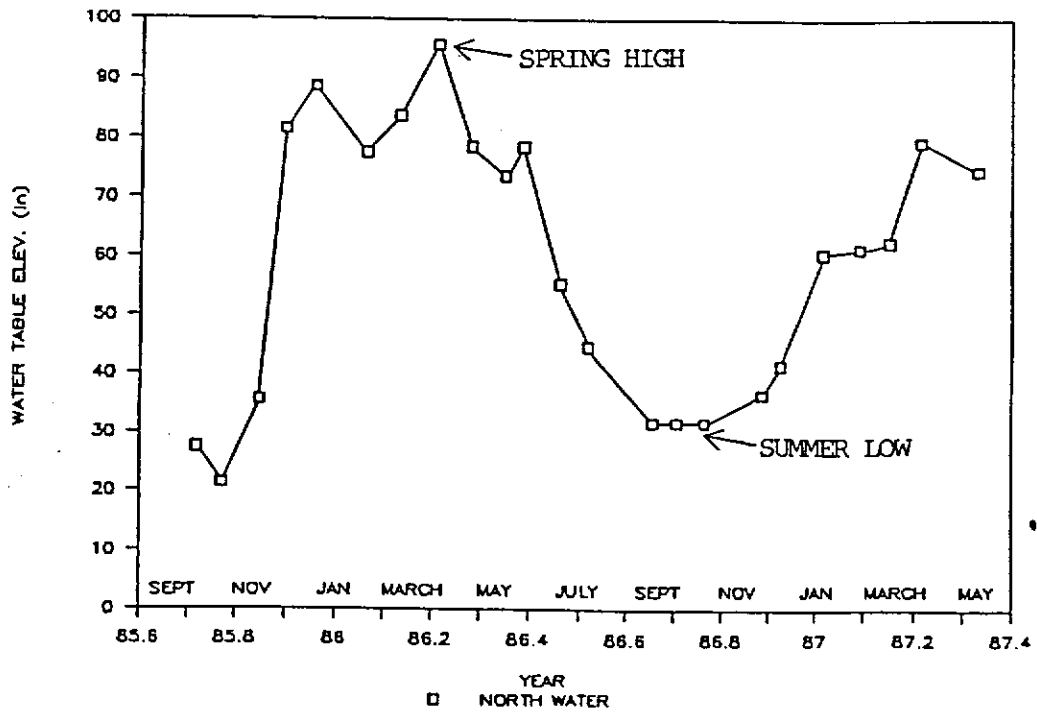
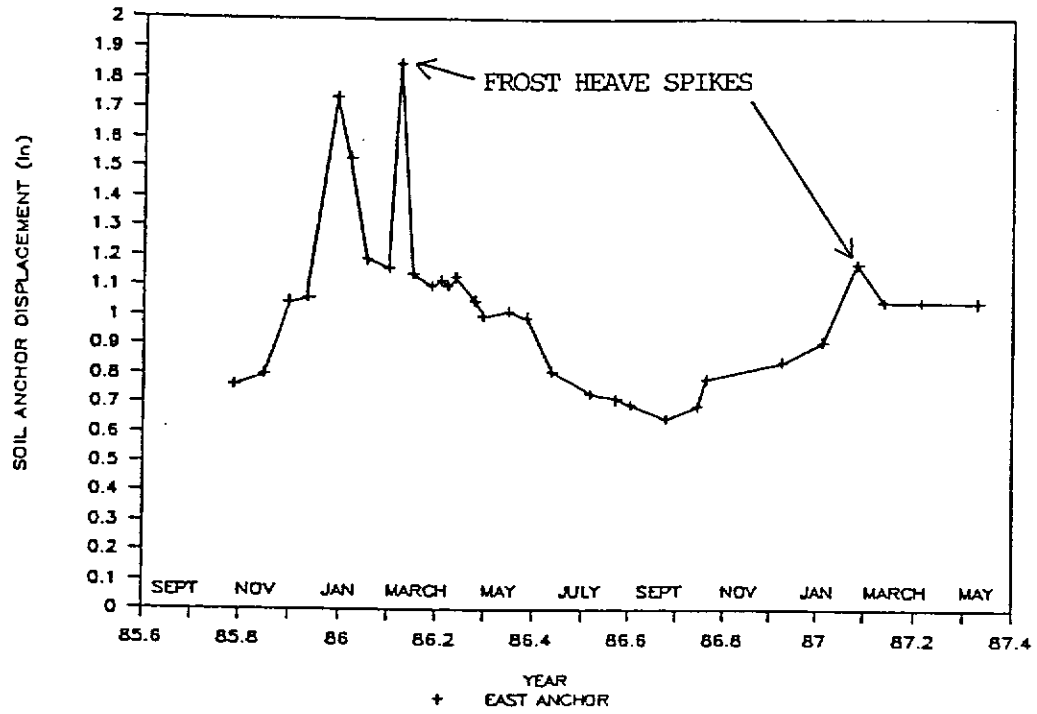

and a summer low. This fluctuation can be expected as a result of the lack of evapotranspiration by plant life and surface evaporation during the winter months. The large trees near the test house can have a large effect near their root systems that is not evident at other locations along the foundation.

Seasonal water table fluctuation correlates quite well in time with the seasonal 0.65 inch settlement and subsequent rise of the top of the soil anchor shown in the same figure. The location of soil anchors near the test home are shown in Figure 2-3. They measure relative movement between the anchor in rock and the top cap at the ground surface as shown in Figure I-2. The soil settles during the summer because it shrinks upon drying much the same way mud shrinks and cracks upon drying. The soil also rises or swells during the fall when the water table rises and the soil becomes more moist.

FROST HEAVE

Soil can heave quite substantially as shown in Figure 3-2 by the frost heave spikes that are superposed on top of the seasonal volume change induced movement of the soil anchor. The spike during 1987 correlated in time with the passage of a cold front as shown by the one week period of below freezing temperatures in the accompanying outside temperature time history. The same correlation exists for the second spike during 1986. Although the temperature

FIGURE 3-2

SOIL DEFORMATION vs. DAILY AVG. TEMP.

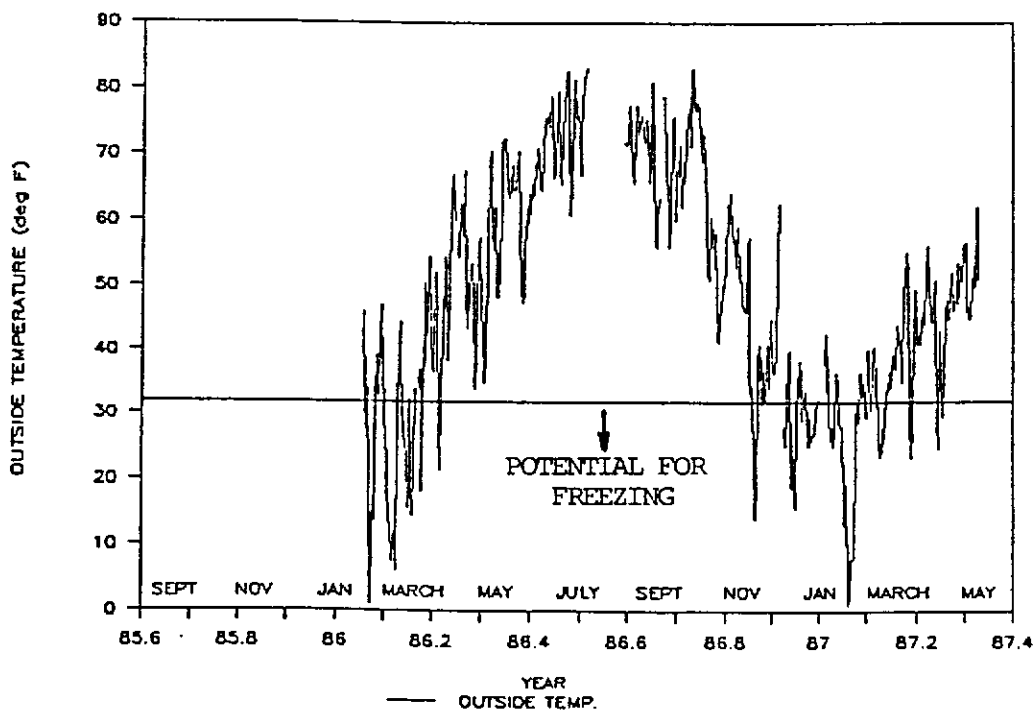
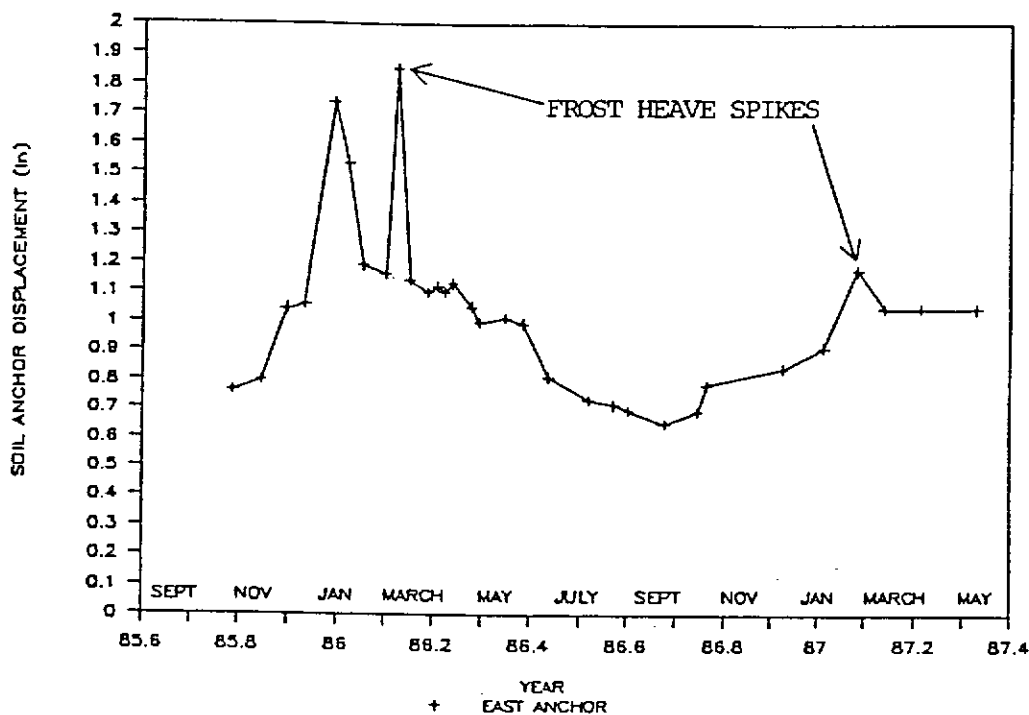

records for 1986 are incomplete, there were more below freezing temperatures for that year than 1987, which was an unusually mild year.

Thus even in the unusually mild winter of 1987, the soil near the test house can be expected to heave as much as 0.15 inch. In a more normal year, the heave is more likely to be 0.7 inch, as shown by the 1986 spikes. Frost heave occurs most intensively in silty soils, which are known to cover much of the area around Blanford and near the Wabash river.

ABSOLUTE VERTICAL RESPONSE MEASURED BY OPTICAL SURVEYING

Absolute movements are most easily measured by optical surveying techniques which depend upon an immovable benchmark and a precise monitoring location. The 10 foot proximity of rock and the three soil anchors grouted to rock near the house provide an unusually efficient benchmark system. The most precise monitoring locations were provided by the stainless steel balls affixed to the house frame. The chiseled X's that marked brick and concrete flatwork monitoring positions were less precise.

Vertical movements of the test house frame and, thus, foundation are compared to the movement of the soil anchors in Figure 3-3. Two extremes of the measured response were chosen for comparison, movement over the shallowly founded, eastern portion of the test house (as shown in Figure 2-2) and over the more deeply founded, western full basement.

FIGURE 3-3

HOUSE MOVEMENT vs. SOIL DEFORMATION

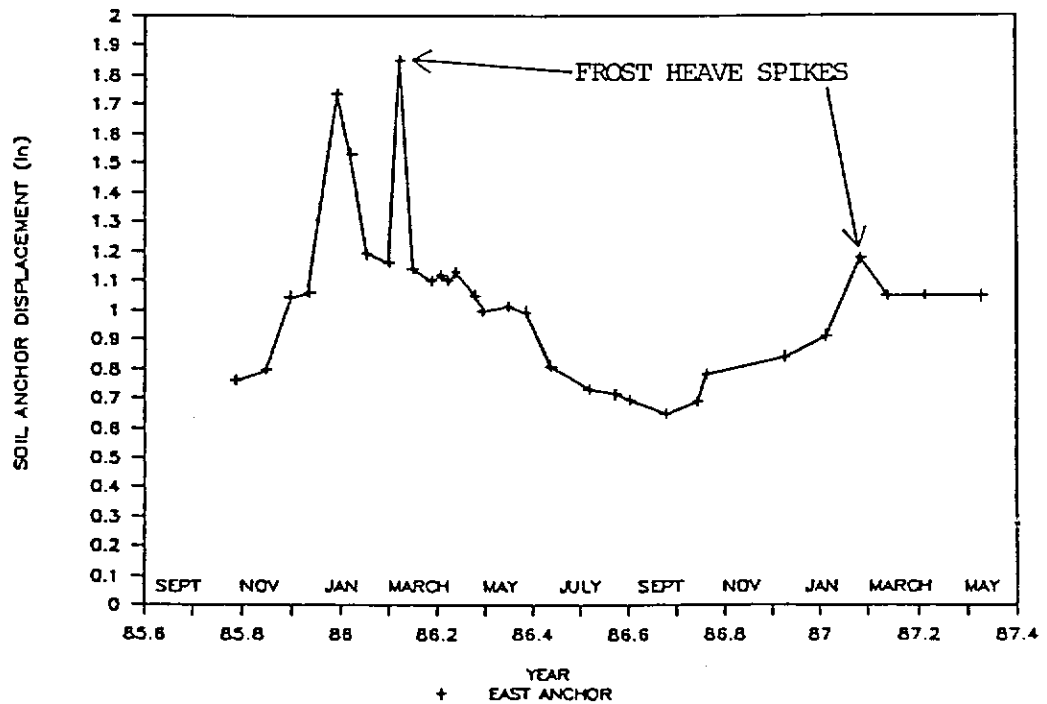
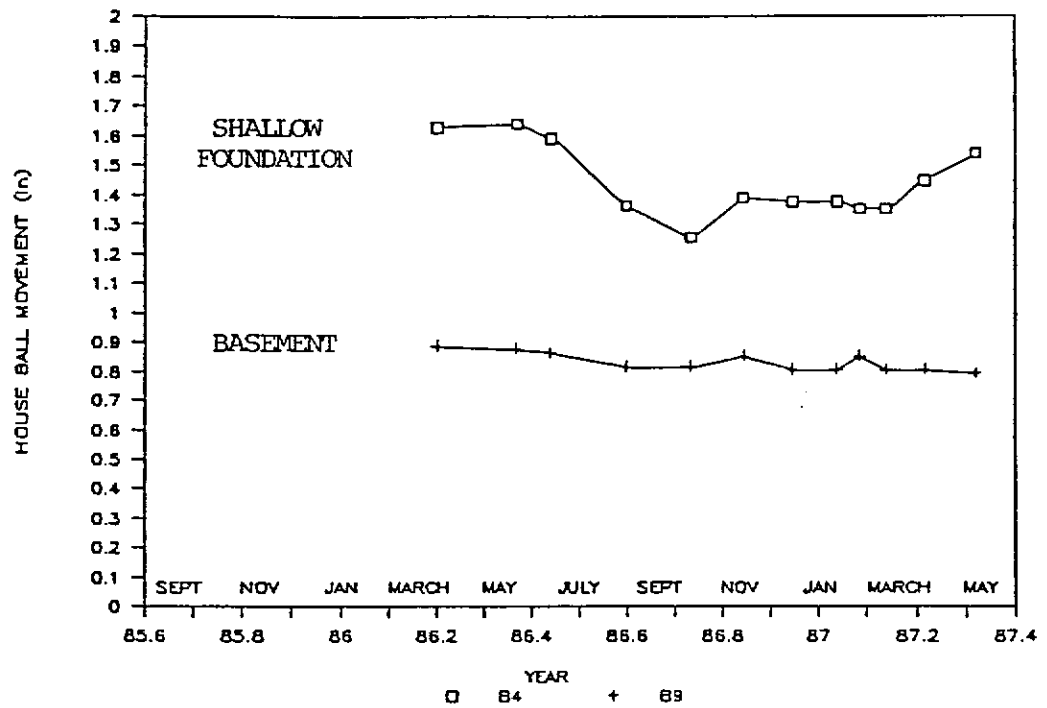

Positions of the two measuring points B9 and B4 are shown in Figure 2-6.

The more shallowly founded portion of the house moved the most for three reasons. First, the soil is thicker below the shallow footing and, therefore, there is a greater volume to shrink/swell. Since rock is only 10 to 11 feet deep, there is only 2 to 3 feet of soil to shrink/swell below the full western basement and 7 to 8 feet of soil below the shallow eastern section. Most importantly, the soil beneath the basement is almost always below the water table and thus always saturated, whereas much of the soil beneath the shallow section is subjected to the seasonal change in moisture content caused by the fluctuating water table. Furthermore, there are large trees on the eastern side of the house near the shallowly founded portion. The roots of these trees are capable of locally lowering the water table during the dry summer months.

Movement of the sidewalk and driveway slabs is compared with the soil anchor movement in Figure 3-4. Positions whose movement is plotted can be found in Figure I-4. It appears that the concrete flatwork moves more irregularly than does the house foundation/frame. These movements are not known with the same precision as for the frame response because the monitoring locations were only marked with chiseled X's and did not force the same precise placement of the target as did the stainless steel balls on the house frame. While movements were as large as 0.5 inches, the

FIGURE 3-4

SLAB & SIDEWALK vs. SOIL DEFORMATION

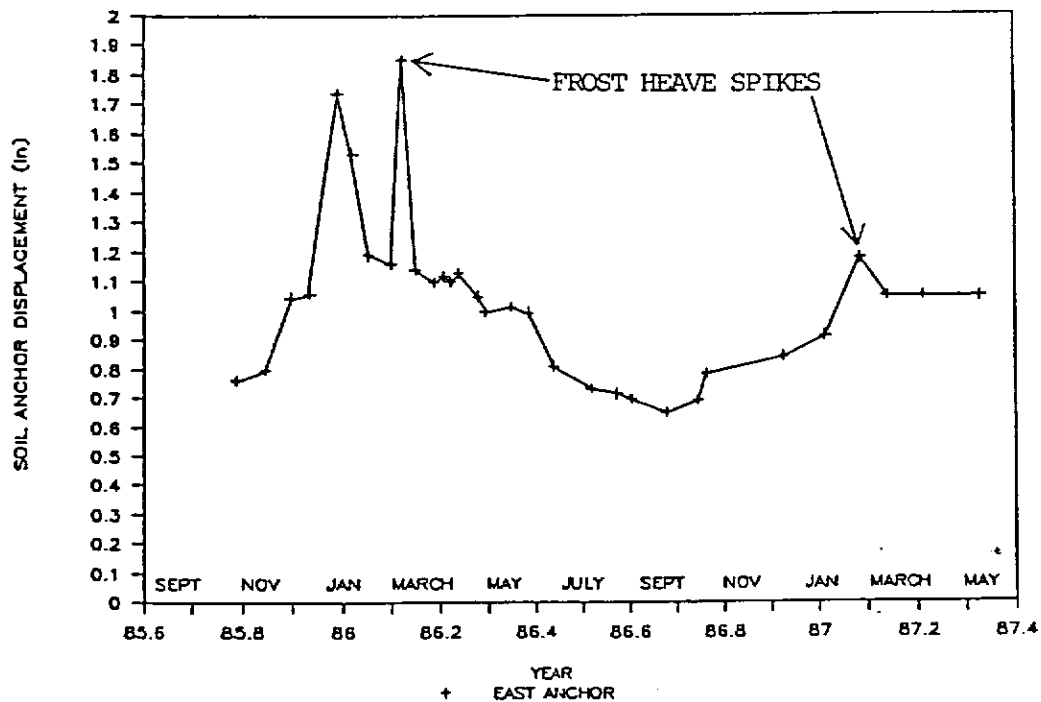
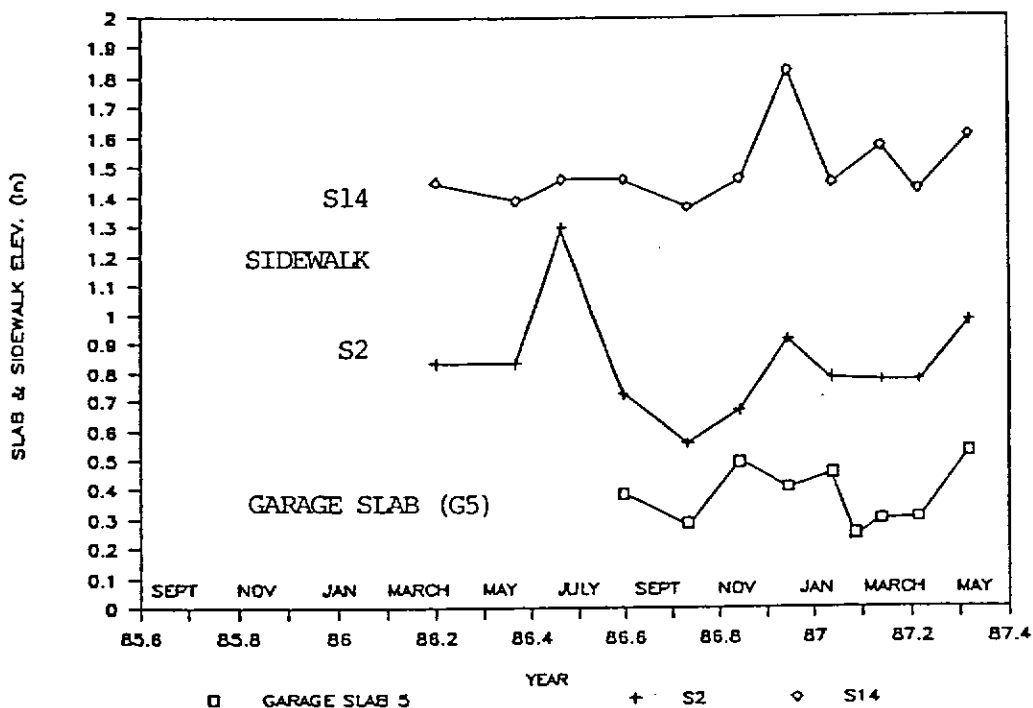

accuracy of these measurements is probably not better than ± 0.1 inches.

RELATIVE RESPONSE MEASURED BY MECHANICAL CRACK GAUGES

While the micrometer gauges (shown in Figure I-7) employed to measure static or long-term crack movement are capable of detecting changes as small as 1/10,000'th of an inch, difficulties in precise placement and reading by interpolation limited their actual precision to 1/500'th of an inch. Despite this limitation, their use allows detection of relative movements 1/10'th that possible with unusually precise optical surveying. Furthermore, this precision is some 20 times better than that possible with many commercially available crack gauges.

Selected crack movements are compared to the soil anchor movement in Figure 3-5. The upper two time histories (positions 1 and 2 in Figure 2-4) are for a crack in the western wall of the garage. The timing of their greatest change coincides exactly with the January, 1987 frost heave spike. The correlation is quite reasonable as the garage walls are founded on 1.2 foot deep strip footings in a climate where frost penetration is some 3.3 to 4.1 feet. Thus, during winter frost penetration, frost heave jacks the slab differentially and distorts the garage foundation and walls. As can be seen in Figure 3-5, this distortion results in crack movement of some 0.02 inches during a mild winter. A more typical winter, such as 1986, could have

FIGURE 3-5

CRACK DEFORMATION vs. SOIL DEFORMATION

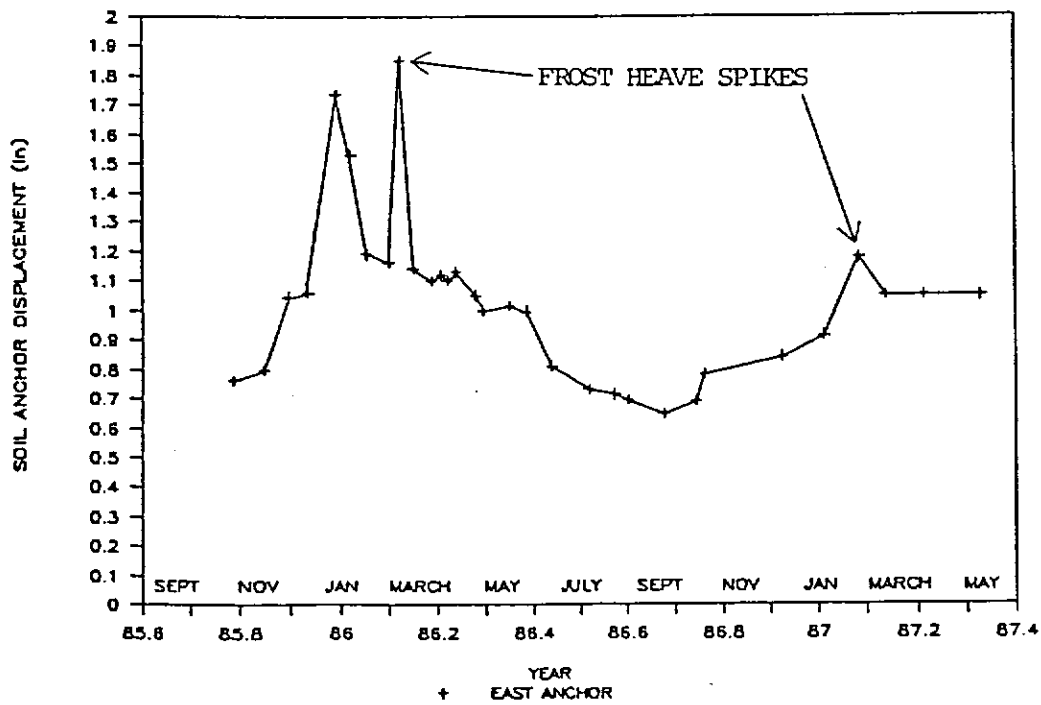
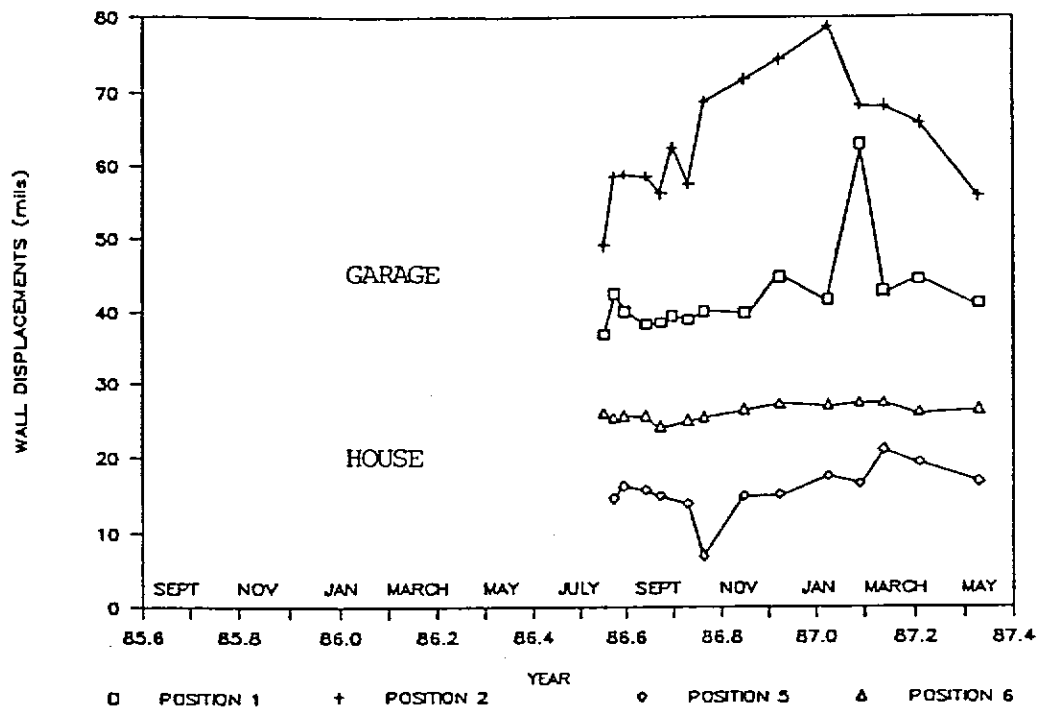

produced crack movements 4 times larger as estimated from the ratio of soil anchor movement for the two winters.

The lower two time histories (positions 5 and 6) are for cracks in the basement of the house and do not display the large variation of the garage crack. As discussed before, the basements are founded below the depth of frost penetration and seasonal soil volume change. Position 5 shows more movement than position 6, which is consistent with position 5's location on an outside wall and position 6's on an interior wall.

MICRO INCH WALL MOVEMENTS FROM INDUCTANCE GAUGES

The Kaman inductance gauges shown in Figure I-5 measured wall displacements as small as 0.000004 inches and, thus, were able to sense response to chemical-thermal movements produced by daily changes in the weather. The combination of high precision gauges and computerized monitoring allowed around-the-clock remote monitoring of the gauges over some eight months time. Altogether, the six inductance gauges were read remotely some 800 times during this period to produce a weather response data bank unequalled in the blasting industry anywhere in the world.

The ability of the Kaman system to monitor for long periods of time without electronic drift can be ascertained by comparing Kaman and micrometer measurements of the movement of the same crack. As shown in Figure 3-6 by such a comparison for movement of the basement crack (positions c8

FIGURE 3-6

YEARLY WALL DISPL. COMPARISON

MANUAL CRACK GAUGE vs. ELECTRONIC GAUGE

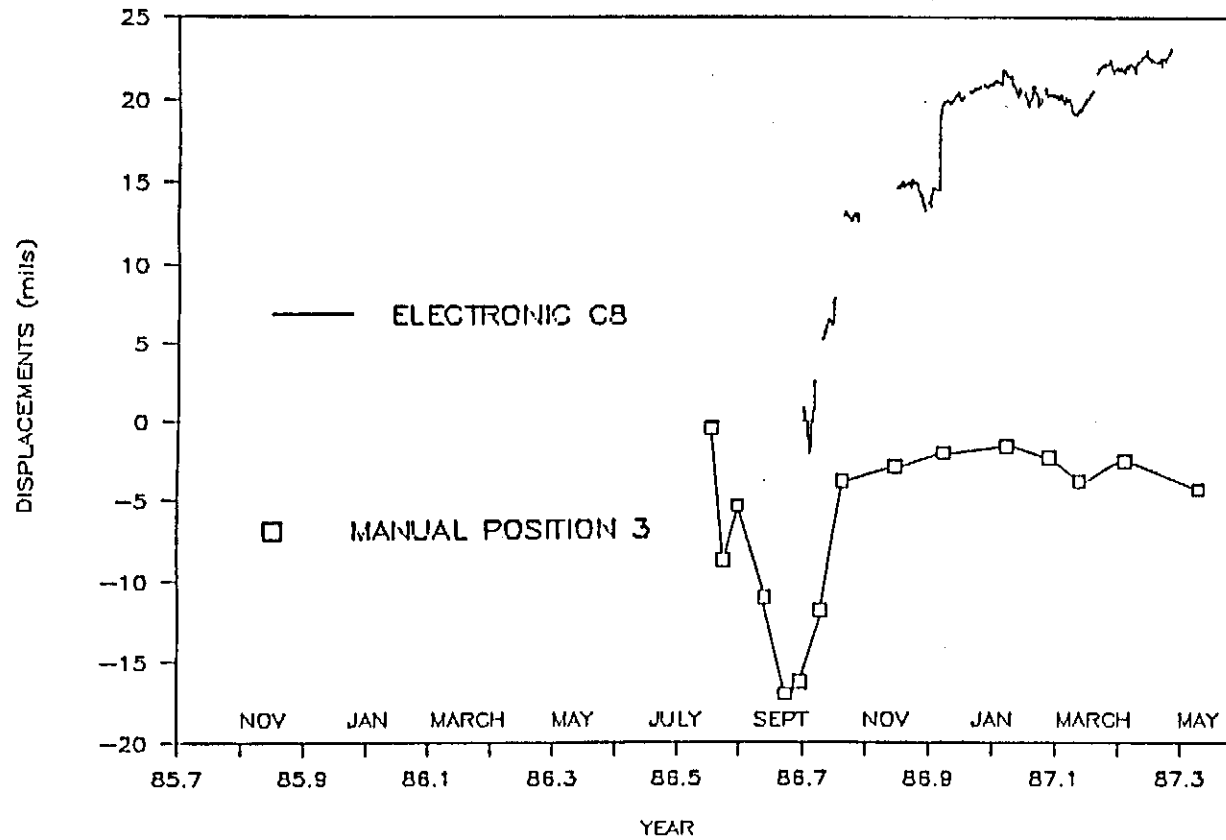

and e3 in Figure 2-4), the Kaman, c8, and micrometer, e3, show the same trends and magnitude of movement over the eight month period. Both show long-term of static crack displacements of 20 mils (1 mil 0.001 inch).

The Kaman system's ability to measure changes independent of gauge temperature is verified by the comparison in Figure 3-7 of the displacements measured during September, 1986 at positions c6 and c7. As shown in Figure I-6, the gauge system itself is sensitive to temperature and must be corrected for such response. Results of such a correction (made for all gauges during the project) for positions 6 and 7 with inside temperature is shown on Figure 3-7, where position 6's displacements increased and position 7's decreased. The opposite direction of the measured displacement verifies that the system meets its intended function. Position 6 is in the middle of a dry-wall sheet and position 7 spans a cracked joint at the northern edge of the sheet to which position 6 is affixed. When position 7 shows positive movement (opening) during passage of the weather front between the 4th and the 10th of the month, position 6 displays negative movement (closure). Such a difference should be expected if the sheet is contracting, which opens the joints. Furthermore, as will be shown later, position 6 displays a consistent shrinkage or closure during the dry winter while position 7 shows opening or expansion.

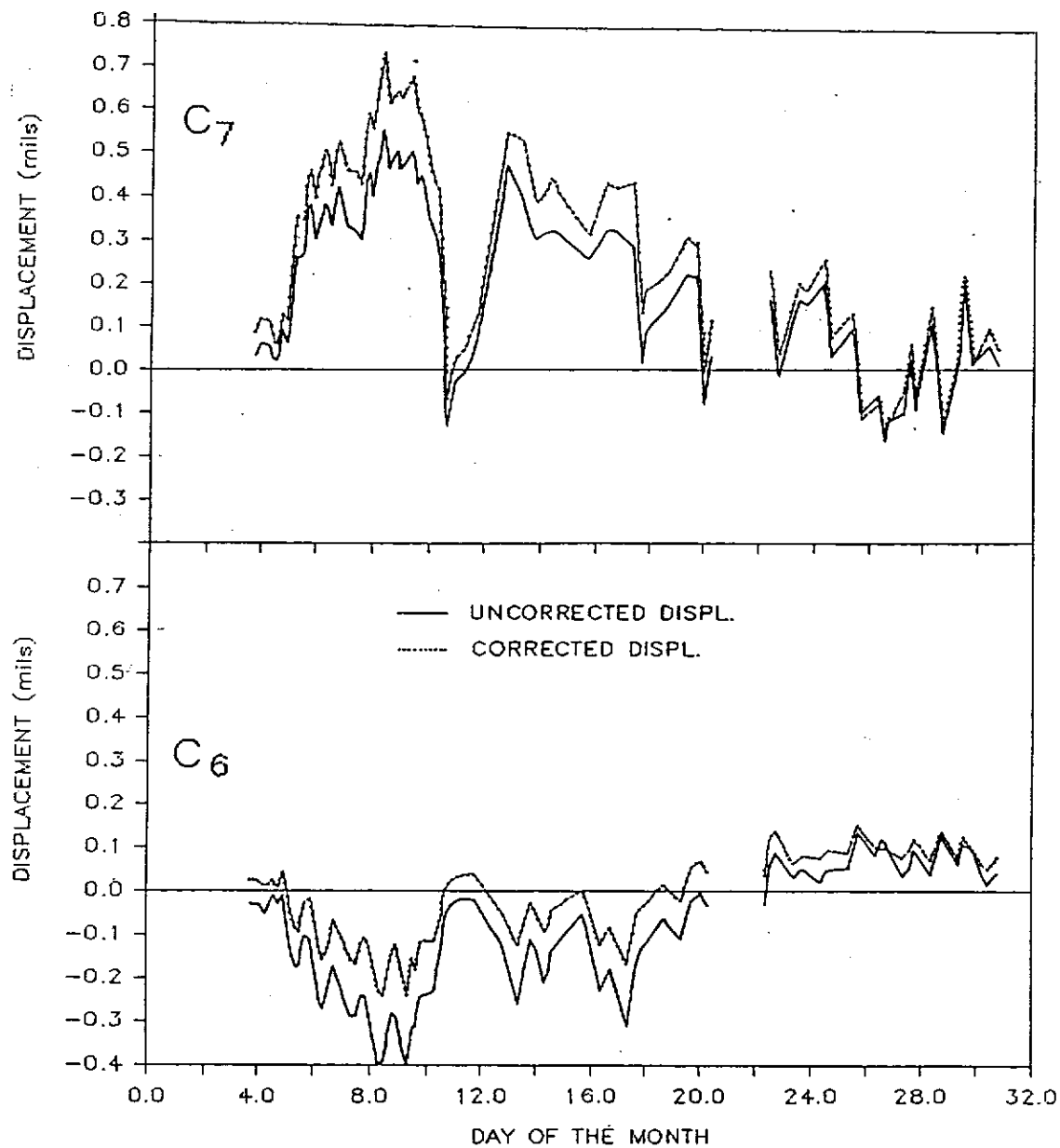

FIGURE 3-7

DISPLACEMENTS PRODUCED BY
 DAILY AND WEATHER FRONT CHANGES DURING SEPTEMBER 1986 IN
 UNCRACKED DRYWALL SHEET (c⁶) AND CRACKED JOINT (c⁷)
 CONTRACTION IS NEGATIVE

CORRELATION OF WALL RESPONSE AND WEATHER CHANGES

Three gauge positions were chosen to demonstrate the sensitivity of wall deformation to changes in the weather or temperature and humidity. These positions (c6, c7, and c10), whose locations are shown in Figure 2-4, represent a wide variety of wall conditions. Position c6 is located in the middle of a drywall sheet, c7 spans a cracked sheet joint at the corner of a door, and c10 crosses an uncracked sheet joint at the junction of the eastern addition and original middle portion of the house. Position c10 is located on the outside wall and shows the most weather and blast response of all gauges placed on that wall. Position c7 is on an interior wall beneath the second story exterior, load bearing wall and shows the most response of any position on the first floor. While position c6 is also beneath the second story wall, it is not near a stress concentrating opening and is in the middle of a drywall sheet. Its response is similar to the other similar position, c2, on the outside wall.

As shown in the one month time history response for positions 6 and 7 in Figure 3-7, a daily cycle is superposed on a weekly cycle. Daily fluctuations are best illustrated between days 4 and 12 where readings were taken every three hours. Weekly fluctuations occur in pulses during the 4th through the 11th, 12th through the 17th, and again during the 25th through the 29th. The daily cycle is smaller than the weekly cycle and is probably a reflection

of the response of the test house to daily temperature changes. The weekly cycle is probably the result of a combination of temperature and humidity changes.

Seasonal and weekly or weather front changes are best illustrated by project duration time histories shown in Figures 3-8 through 3-11, where wall displacements are compared to outside and inside humidity and temperature, respectively. Only the relative values of the wall displacements are important as the absolute values were chosen to facilitate plotting three responses on the same graph. A quick comparison of the temperature and humidity variations show inside fluctuations from weekly weather fronts to be far smaller than those outside, which is to be expected because of the compensation of the heating system. The heating system does dry out the inside of the house as shown by the winter depression of the average inside humidity in comparison with the more constant average humidity outside.

As shown in Figure 3-8, weekly or frontal weather change responses are superposed on seasonal fluctuations where it is evident that the weekly weather induced responses are equal and sometimes greater than the seasonal responses. Of all four possible weather factors, the outside humidity correlates best with the peaks in the wall displacements and is shown by the circles in Figure 3-8. Since position c7 is the most responsive crack, its peaks have been

FIGURE 3-8

WALL DISPLACEMENTS vs. DAILY AVG. HUMID.

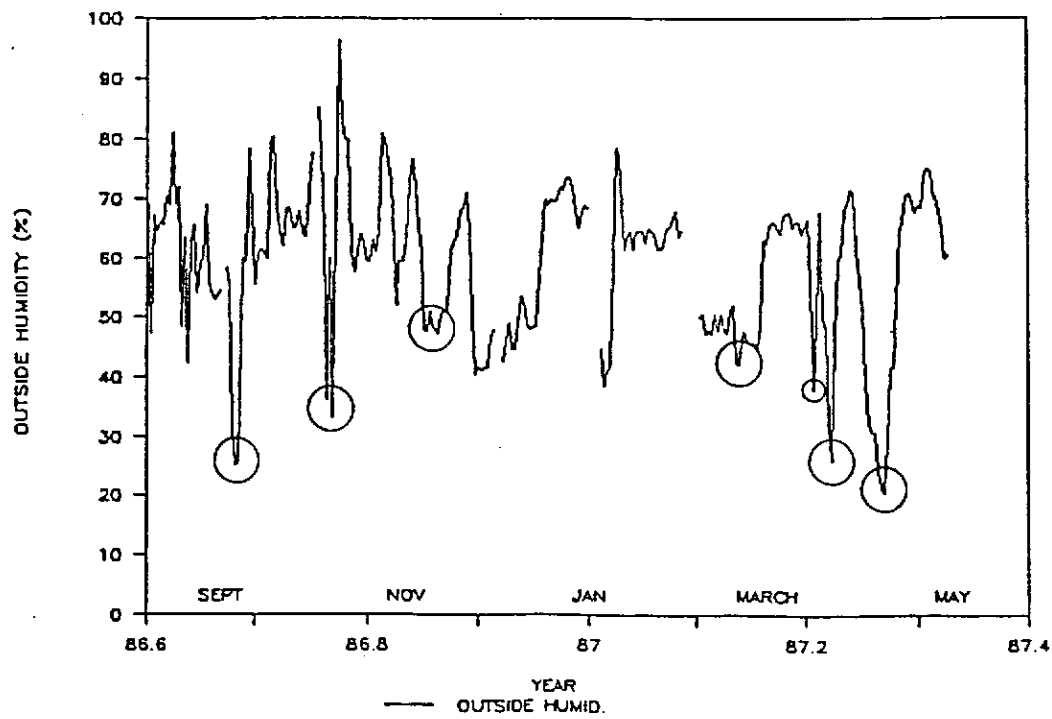
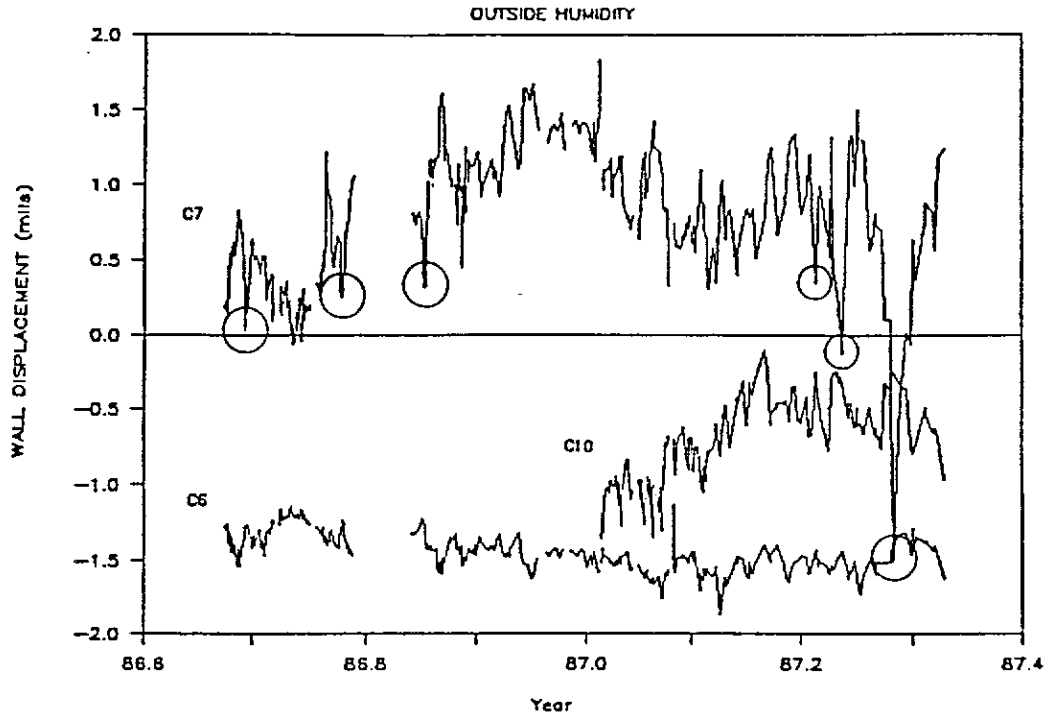

FIGURE 3-9
 WALL DISPLACEMENTS vs. DAILY AVG. TEMP.

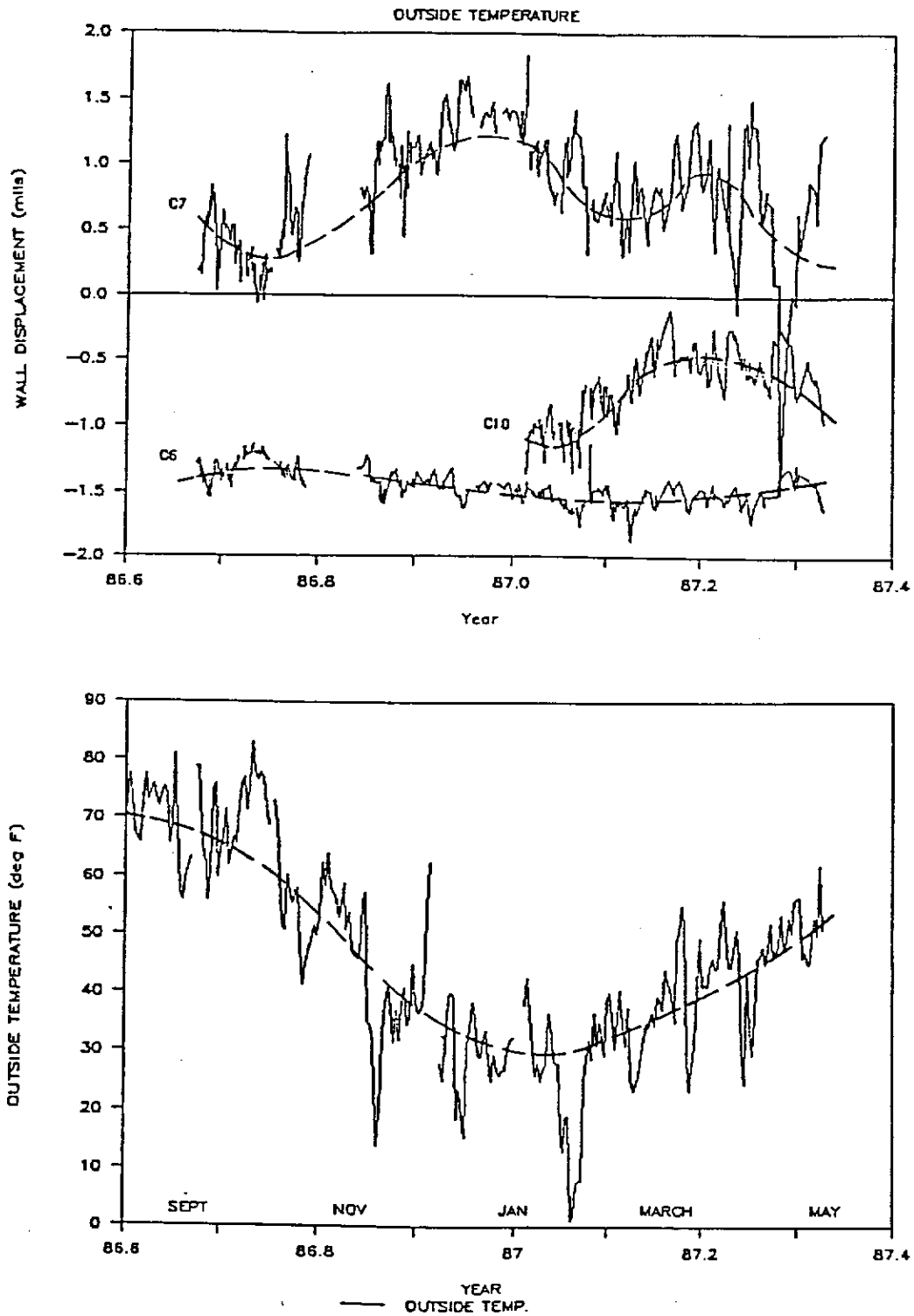

FIGURE 3-10

WALL DISPLACEMENTS vs. DAILY AVG. HUMID.

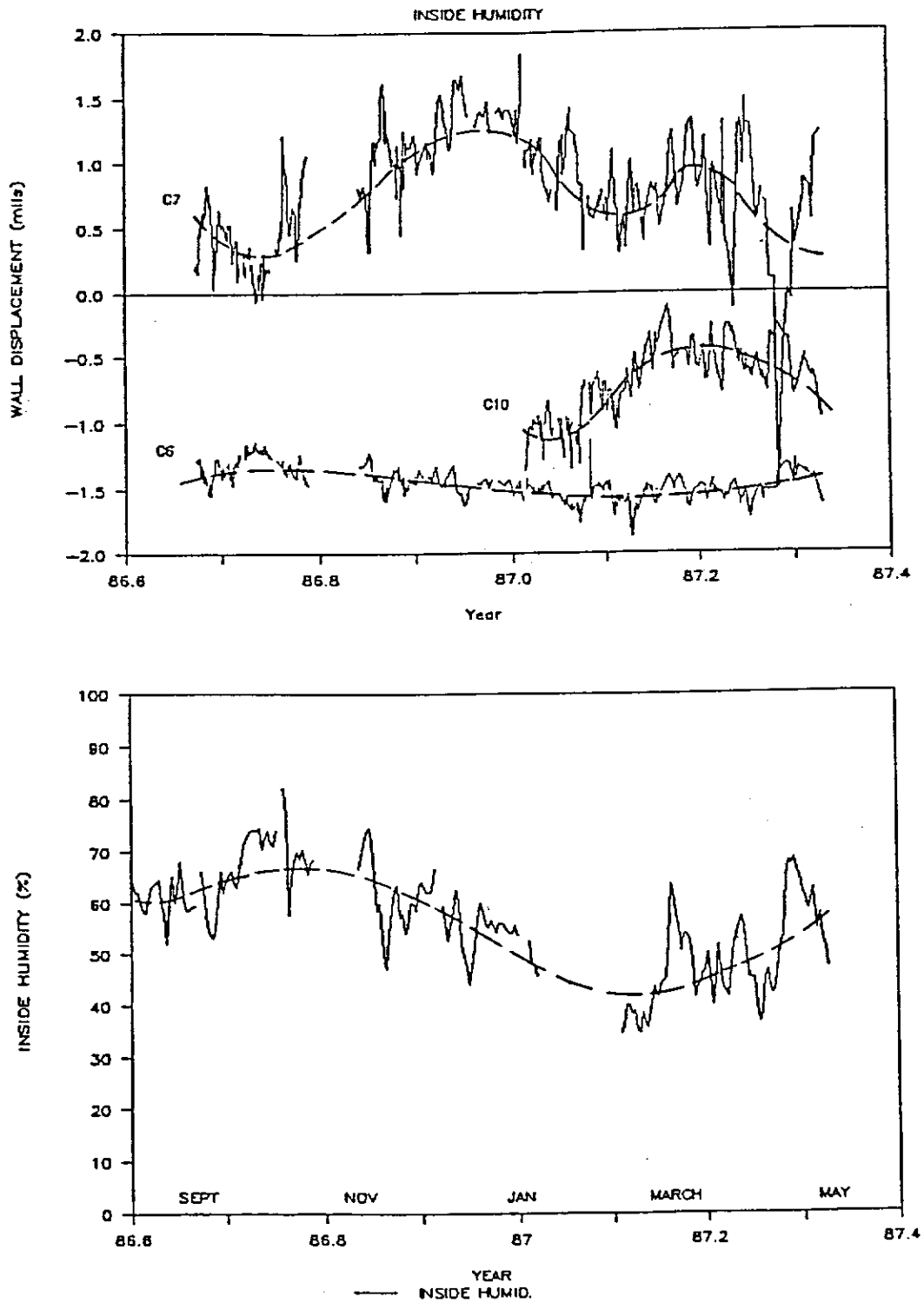
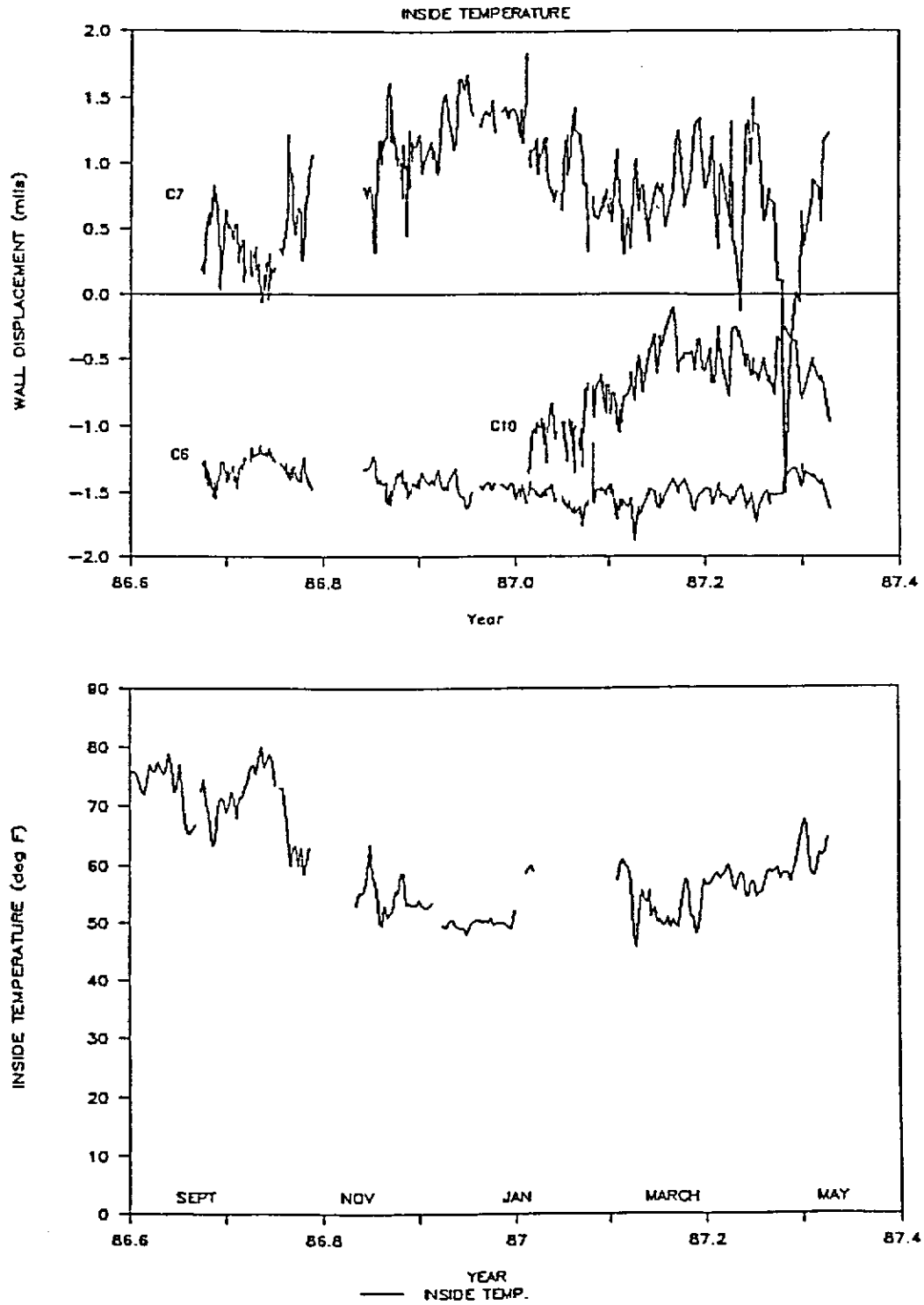

FIGURE 3-11

WALL DISPLACEMENTS vs. DAILY AVG. TEMP.



circled; however, in a similar manner, c10 responds with peaks that correlate to extremes in outside humidity.

Daily, weekly, and seasonal fluctuations in the response of these three cracks were separated in order to calculate the average values shown in Table 3-1. Seasonal extremes were determined as the variation about the average of one full year with the unknown four month average assumed to be symmetrical. Weekly extremes were determined as differences between the weather front peaks and the moving seasonal average for the observation period. Daily extremes were determined as differences between the daily peaks and the moving weekly average only for the periods with more than four readings per day. Thus Table 3-1 shows that, on the average every week, the crack above the doorway, c7, is subjected to 0.477 mils (0.000477 inches) of displacement by changes in weather.

TABLE 3-1

WEATHER INDUCED DISPLACEMENTS (mils)

<u>Location</u>	<u>Daily</u>		<u>Weekly</u>		<u>Seasonal</u>
	<u>Average</u>	<u>Maximum</u>	<u>Average</u>	<u>Maximum</u>	<u>Average</u>
c6	0.044	0.063	0.111	0.181	0.098
c7	0.067	0.129	0.477	1.233	0.350
c10	0.096	0.198	0.231	0.397	0.232

BLASTING ENVIRONMENT

The test house is the most southeasternly structure in Blanford, and, as such, it is the closest home to the Universal Mine as shown in Figure 4-1. During the eight month period of intense observation, the average distance from blasting to the test house was 2,000 feet. The sequence of numbered blocks in Figure 4-1 corresponds to the areas of rock fragmented by blasts on the successive dates shown in Table 4-1. Mining progressed in a north-south direction along a 100 foot high wall of unmined rock and resulted in a gradual movement of the high wall to the west. During this time, additional mining in a more distant southern pit produced low level vibrations at the test house.

TYPICAL BLASTING PATTERN AND GROUND MOTIONS

The November 5, 1987 blast produced a typical level of ground motion at the test house, some 1,950 feet away. The 0.14 ips peak particle velocity is slightly above the median recorded during the study; thus, more than 50% of the blasts produced less intense ground motions. For that blast some 54, 100 foot deep blast holes were arranged in six north-south oriented rows and each were loaded with 675 lbs of explosive. Explosives in each hole were detonated

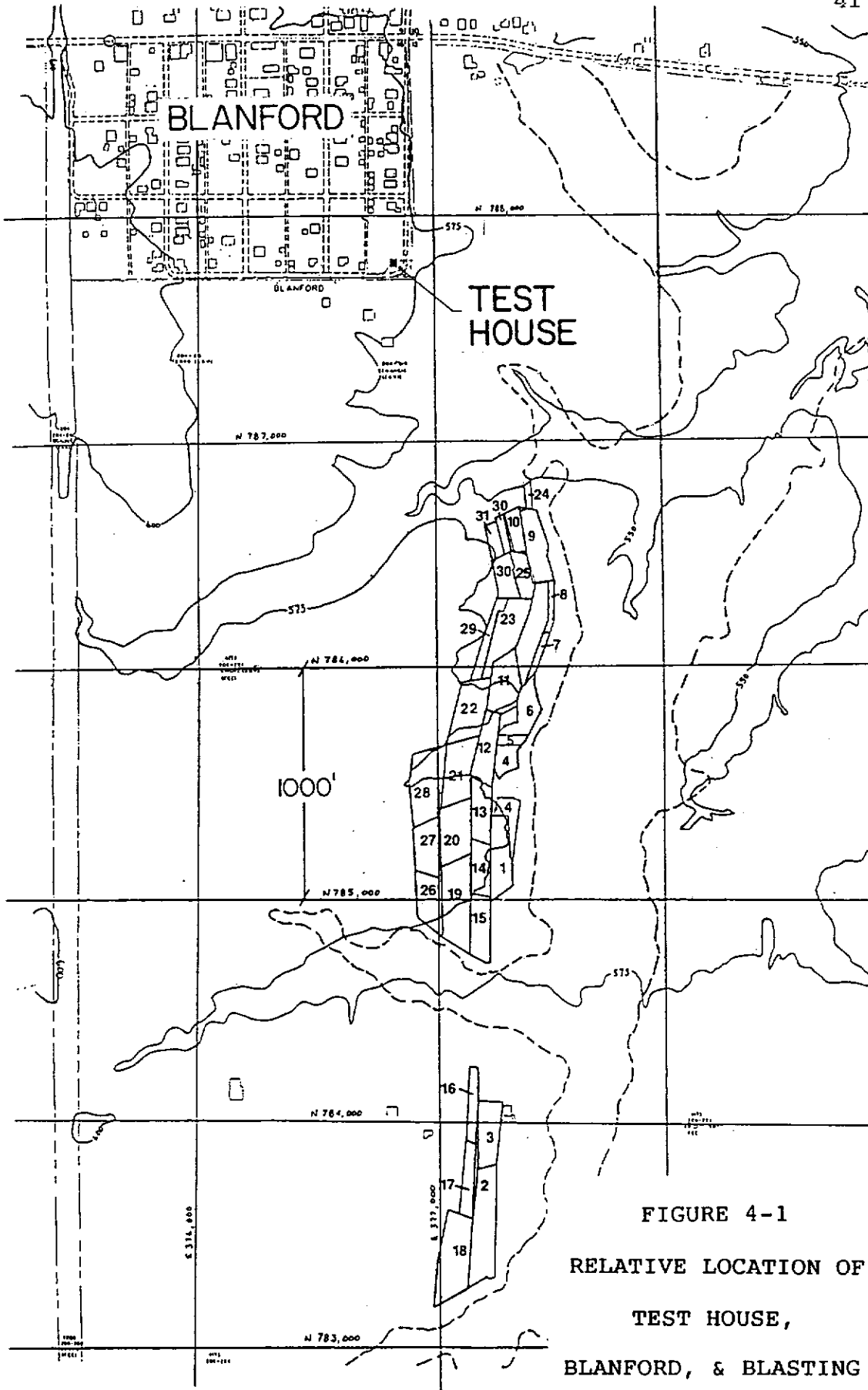

FIGURE 4-1
RELATIVE LOCATION OF
TEST HOUSE,
BLANFORD, & BLASTING

TABLE 4-1
RELATIONSHIP BETWEEN
LOCATION DATE AND MAXIMUM GROUND MOTION

Location	Date	Maximum Ground Motion	Frequency @ Max Ground Motion (Hz)
1	10/13/87	.10	18
2	10/22/87	.08	5
3	10/27/87	.06	10
4	10/29/87	NR	
5	10/29/87	NR	
6	11/01/87	NR	
7	11/05/87	.14	9
8	11/07/87	0.23	36
9	11/14/87	0.30	21
10	11/18/87	0.55	23
11	11/21/87	0.44	21
11a	11/24/87	0.23	17
12	11/24/87	0.17	17
13	11/25/87	0.23	16
14	11/26/87	0.18	13
15	11/26/87	0.12	16
16	12/01/87	0.07	15
17	12/03/87	0.07	16
18	12/08/87	0.05	15
19	12/11/87	0.15	16
20	12/12/87	0.18	11
21	12/13/87	0.20	16
22	12/15/87	0.19	7
23	12/19/87	0.30	18
24	12/21/87	NR	
25	12/22/87	0.35	5
26	12/22/87	0.30	10
27	12/27/87	NR	
28	12/29/87	0.25	5
29	12/29/87	0.31	13
30	12/30/87	0.44	12
31	12/31/87	0.74	18

NR = no record below threshold

at four different times so that only a maximum of 175 lbs were detonated at any one instant.

During eight months of monitoring, some 304 blast induced ground motions were recorded at the test house. Thus, on the average 1.3 events vibrated the house on any day. These motions were at least 0.02 ips, the level at which the unit triggered; however, many were produced by the mining activity at the more distant southern pit. Typically blasts were detonated between 9-10 a.m., 12-1 p.m., and 3-4 p.m.

Occurrence of various levels of recorded ground motion is plotted in Figure 4-2. As can be seen by the left ending distribution, most of the motion occurs at a low level, less than the median of 0.12 ips. The median is the level that divides the data in half. Only 3% of the recorded ground motion exceeded 0.5 ips.

Occurrence of blast induced air overpressure is presented in a similar fashion in Figure 4-3. The median or midpoint of the distribution is only 102 dB, and no overpressure exceeded 120 dB.

COMPARISON OF EXCITATION WITH GUIDELINES

The meaning of these recorded levels can be determined by comparison with existing guidelines. Indiana has adopted controls of 1 ips for ground motion and 130 dB for air overpressure. None of the excitation exceeded these

FIGURE 4-2
OCCURENCES OF PEAK PARTICLE VELOCITY

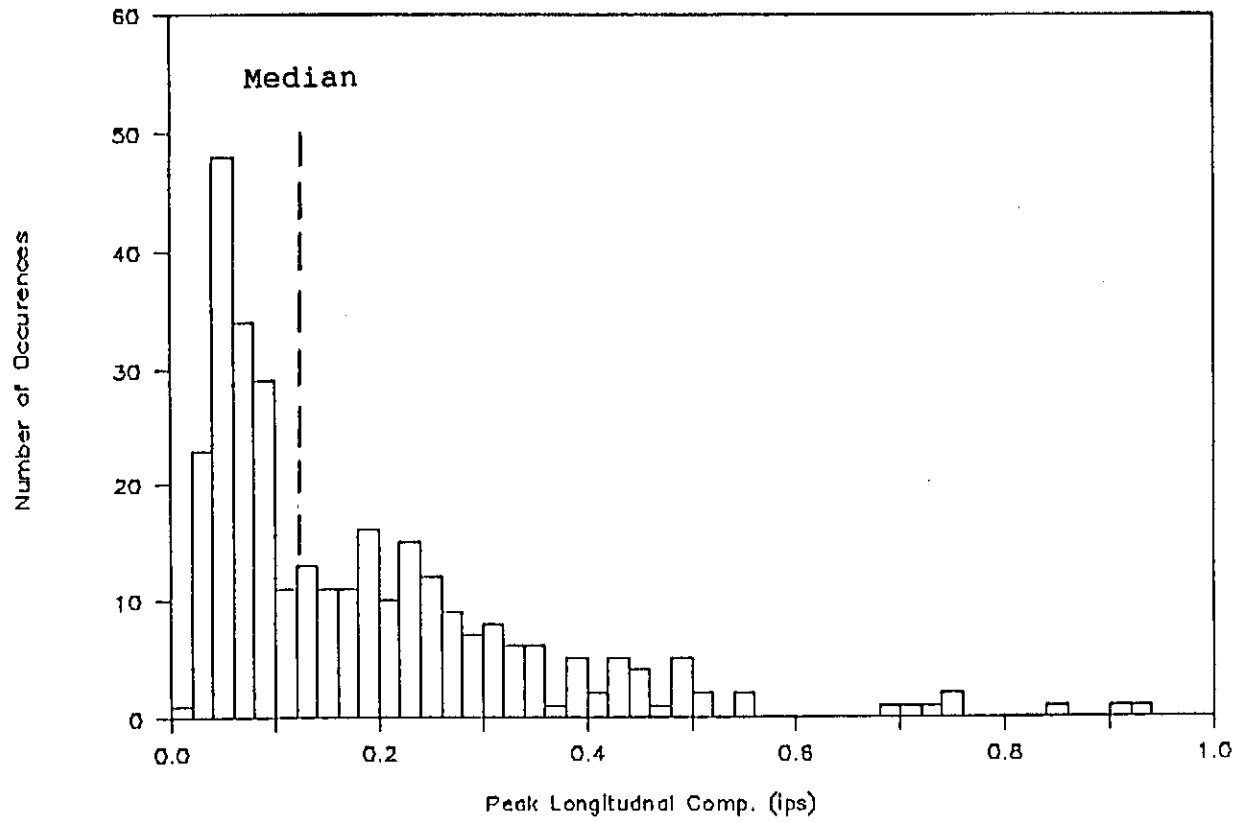
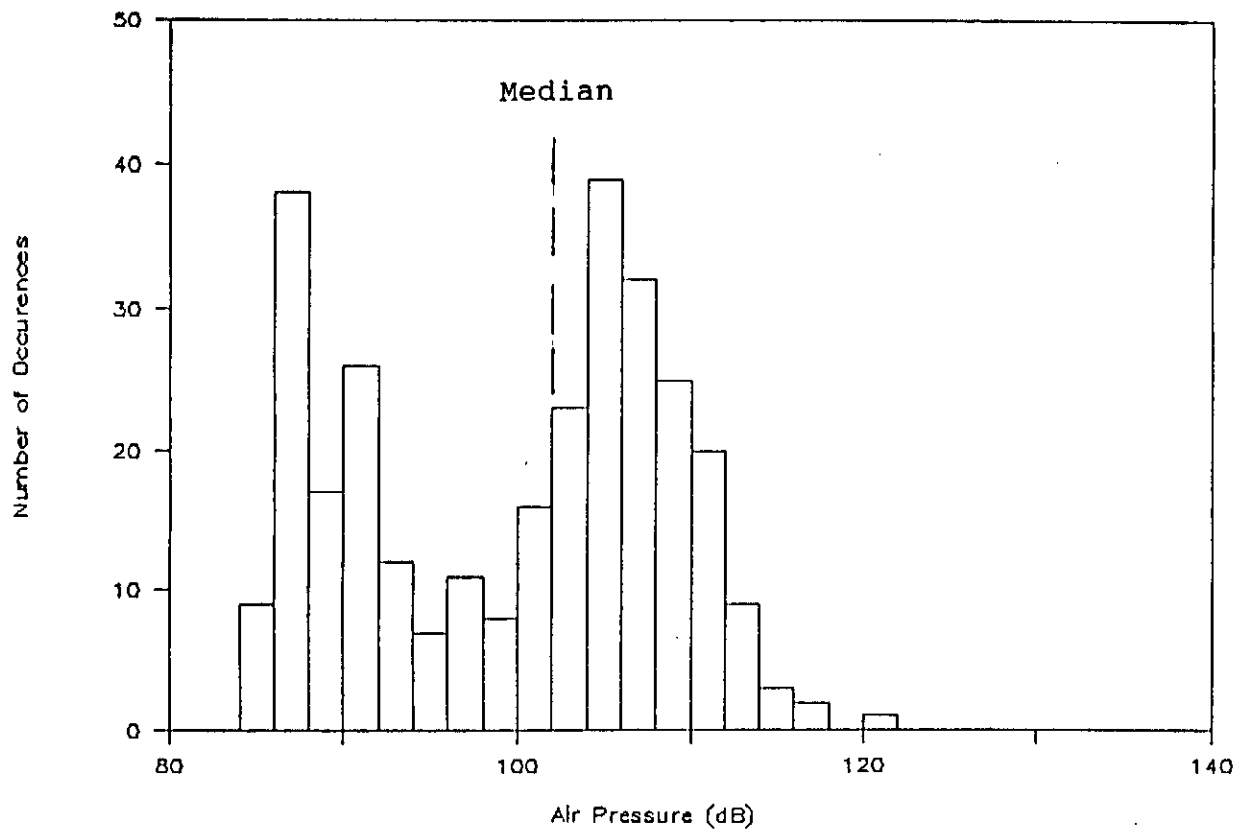

FIGURE 4-3
OCCURENCES OF PEAK AIR PRESSURE (dB)



precautionary levels. In fact, only 3% exceeded a level of 50% the control level.

If the dominant frequency of the ground motion (particle velocity) is taken into account, then the allowable motion is somewhat proportional to the dominant frequency. A tentative guide for such a frequency based control is shown by the solid line in Figure 4-4 (Siskind et al., 1980). Frequency is the number of times per second the ground vibrates up and down as the wave of motion passes by, and the dominant frequency is that associated with the peak or maximum particle velocity as shown by the insert in the figure. Below 20 Hz (20 cycles per second), the suggested limit is less than 1.0 ips.

Despite the more restrictive frequency based control, none of the 304 blast induced ground motion events exceeded the control limit, as can be seen by comparing the limits with the event stars in Figure 4-4. Each star on the plot represents the peak particle velocity and its associated dominant frequency. There appears to be a lack of high particle velocities with dominant frequencies below 10 Hz.

FIGURE 4-4

PEAK PARTICLE VELOCITY vs. FREQUENCY
Longitudinal or Transverse Component

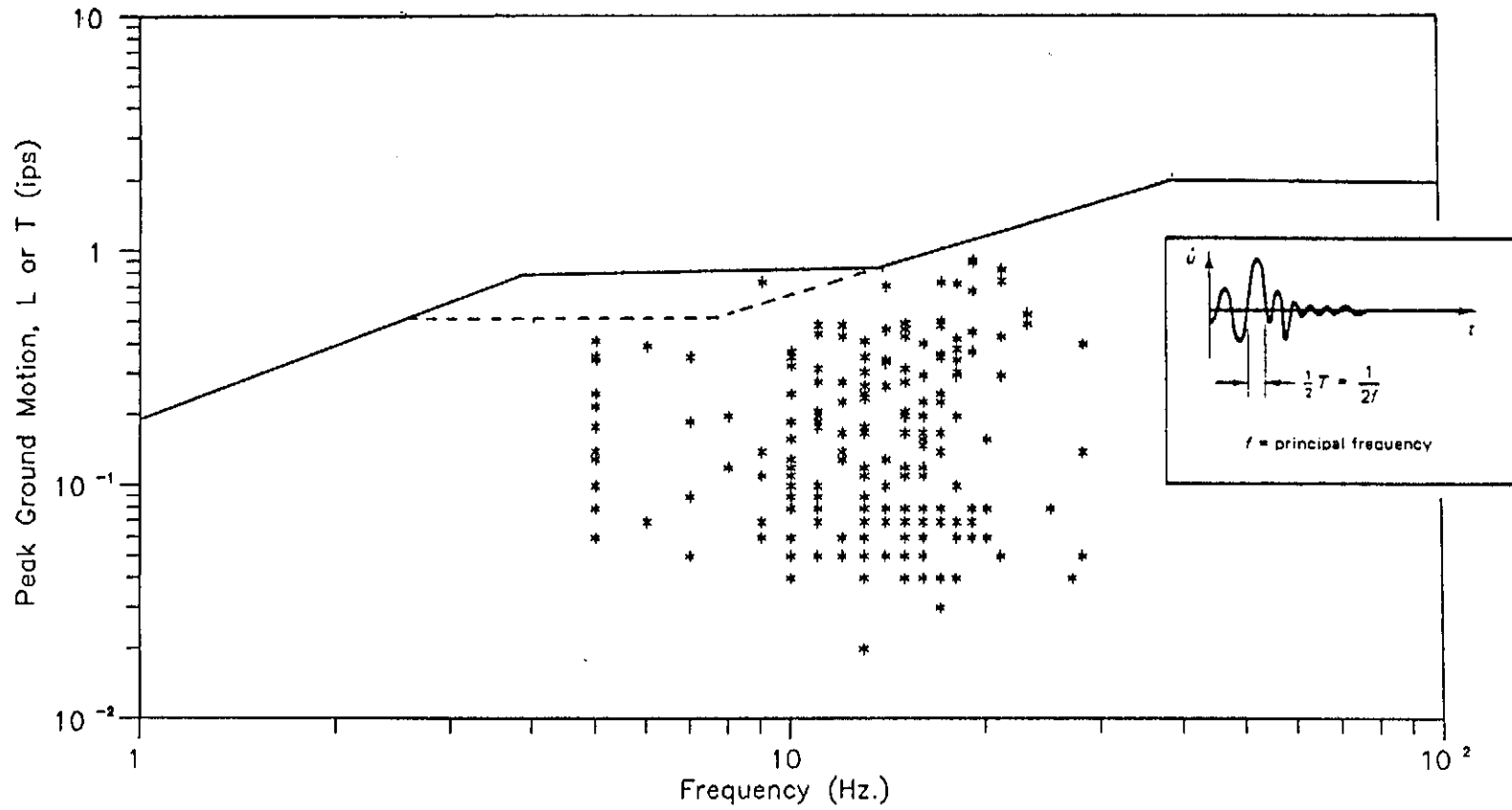

COMPARISON OF ENVIRONMENTAL & BLAST INDUCED WALL DISPLACEMENTS

Simultaneous measurement of both environmental and blast induced wall displacements was made possible by combining Tele-Blast's computerized data acquisition capabilities with the Kaman inductance gauge's long-term stability and dynamic response capabilities. This is the first time both environmental and blast displacements have been measured with the same gauge in a remote fashion over a period of eight months. Thus, the system significantly advances the art of structural response monitoring. Details of the Tele-Blast and Kaman systems are presented in Appendix I under "Dynamic Crack/Wall Displacements".

COMPUTERIZED MONITORING ALLOWS SIMULTANEOUS MEASUREMENTS

Continuous, remote monitoring of house response that can be triggered by either ground or wall motion has allowed unattended recording of environmental excitation heretofore impossible. Response of the test house to thunder, temperature and humidity changes, and human activity has been measured without anyone in attendance. The system is so sensitive that it is possible to detect by telephone in Chicago the arrival of the cleaning service at the test house in Blanford, Indiana.

The most significant attribute of the system for the comparison of environmental and blast displacements is their measurement by the same gauge at the same location. The same gauge can detect changes in displacement that have durations from .002 second -blasts- to 6 months, or (16,000,000 seconds) - seasonal changes. Thus, the time sensitivity spans some 9 orders of magnitude. Since the same gauge measure both environmental and blast effects, their comparison can be made directly without any calculation or conversion.

COMPARISONS ARE MADE FOR VARIABLE WALL CONDITIONS

Environmental and blast induced displacements are compared directly by transducer location in Figures 5-1 through 5-4 in units of mils, where a mil is 1/1000'th of an inch. The eight monitored locations are grouped in pairs by similar environmental response. Their locations are shown in Figures 2-2 and 2-4. The first four, c1, c2, c3, and c6 on the middle of drywall sheets, have the least response. The next two, c9 and c10 located across uncracked drywall joints between sheets, are more sensitive. Most sensitive of all, c7 and c8, respectively span a cracked joint between drywall sheets and a large mortar joint crack in the basement concrete block.

These transducer locations are the result of an effort to find positions of greatest response. Knowledge of the structure gained during the initial condition survey was

FIGURE 5-1

Weather vs. Blast Induced Wall Displ.

Wall displ., C1 vs. max. dynamic displ.

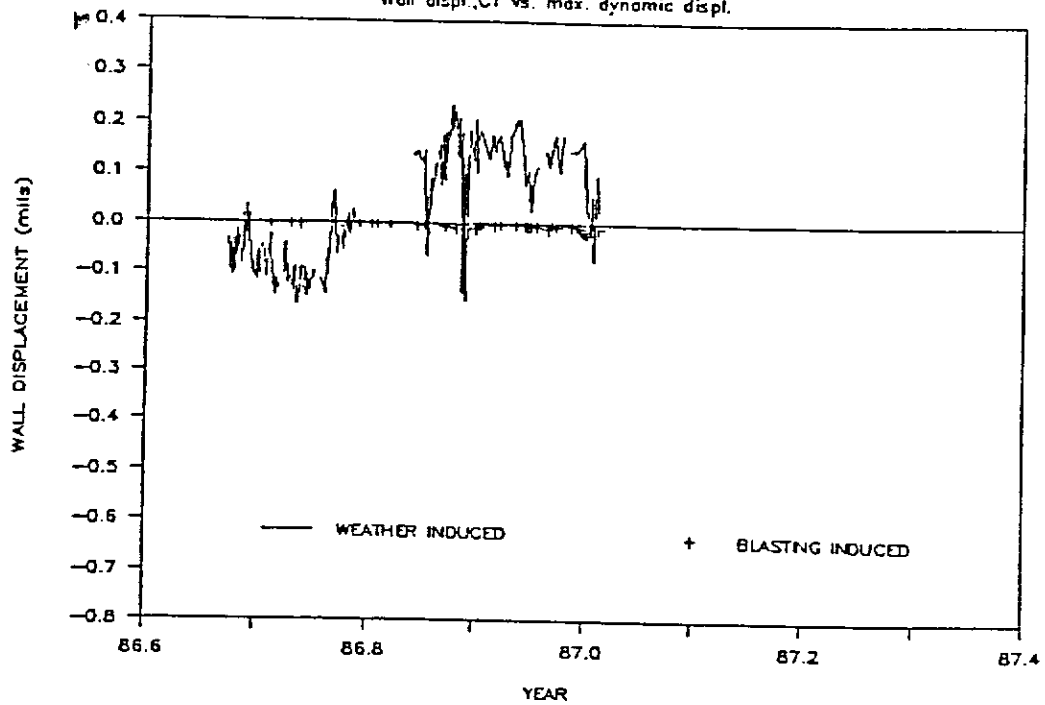

Weather vs. Blast Induced Wall Displ.

Wall displ., C2 vs. max. dynamic displ.

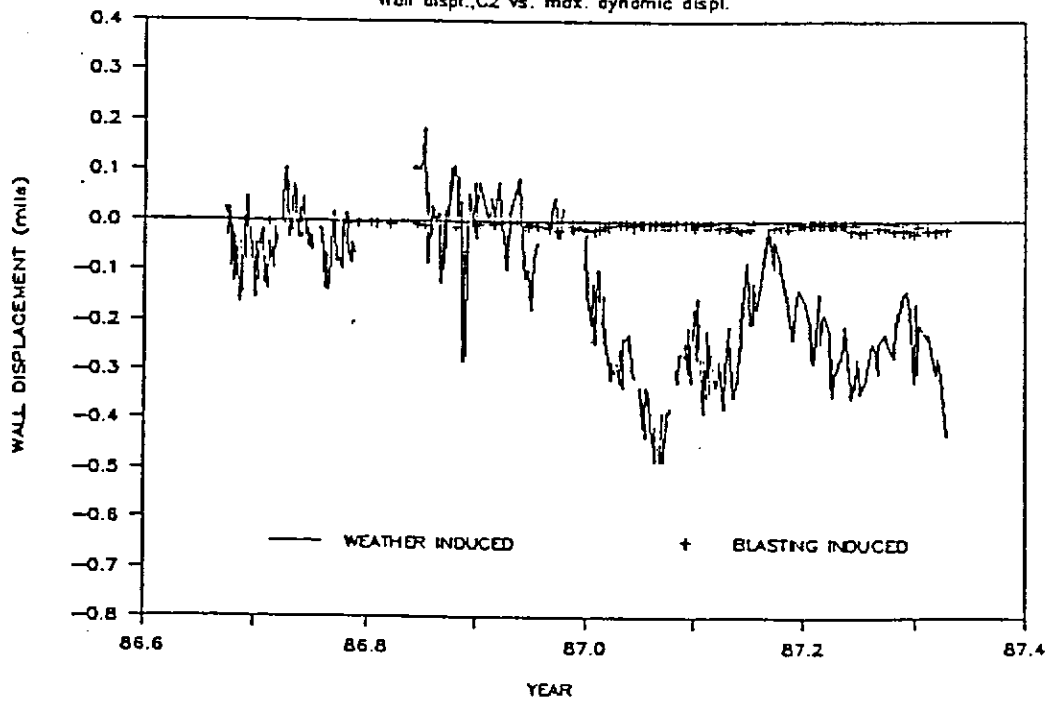
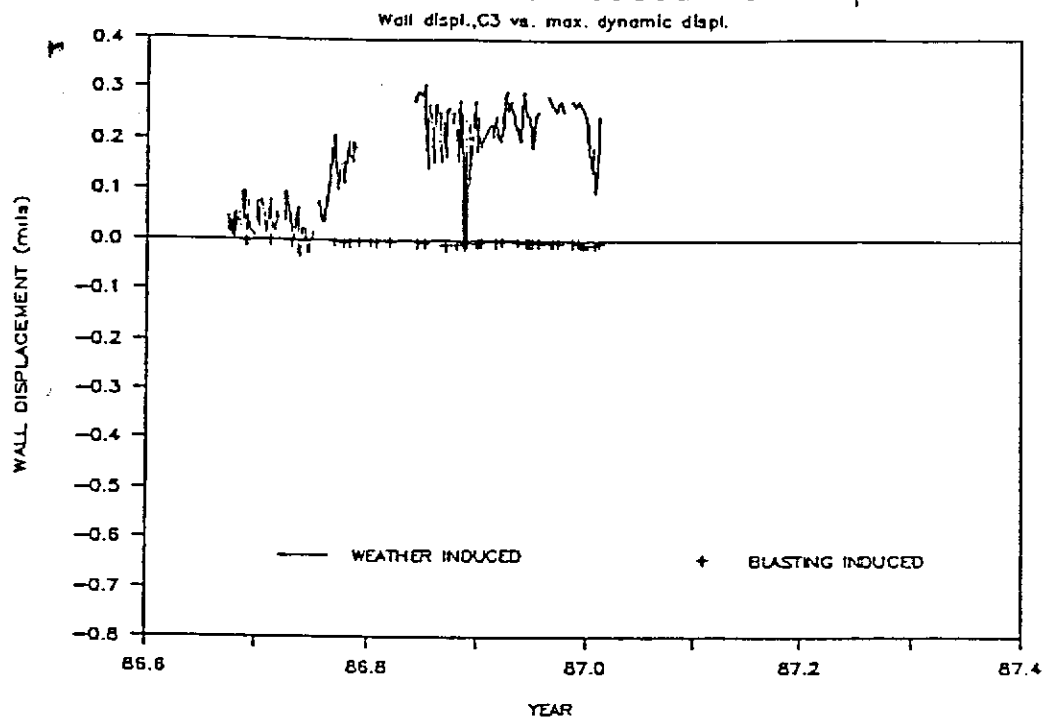

FIGURE 5-2

Weather vs. Blast Induced Wall Displ.



Weather vs. Blast Induced Wall Displ.

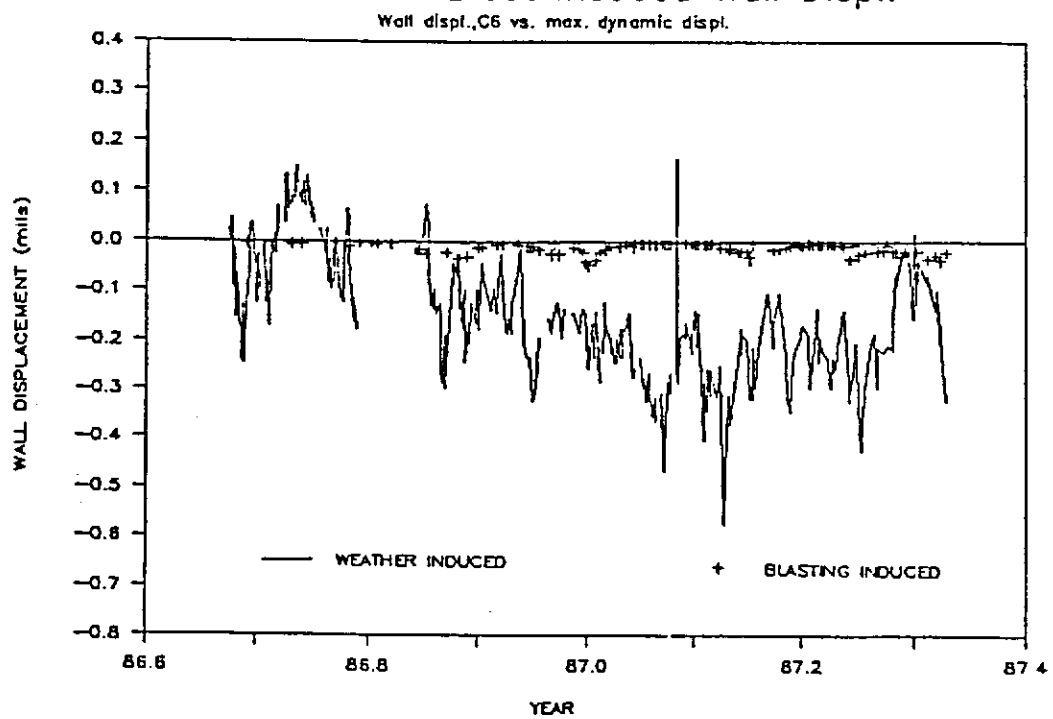
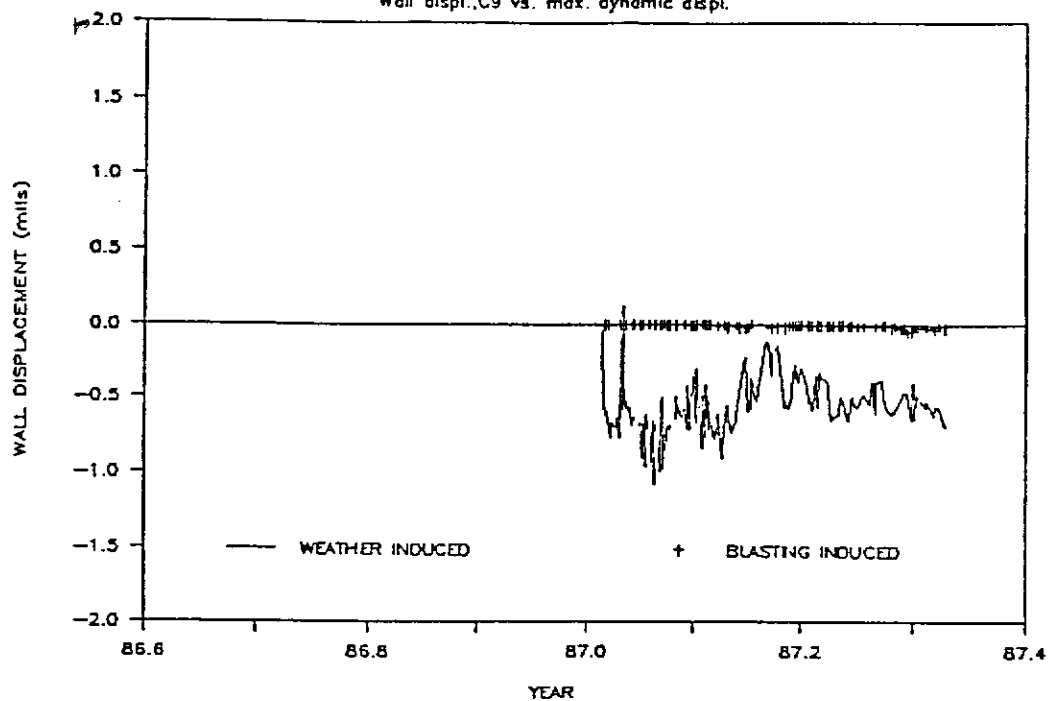

FIGURE 5-3

Weather vs. Blast Induced Wall Displ.

Wall displ., C9 vs. max. dynamic displ.



Weather vs. Blast Induced Wall Displ.

Wall displ., C10 vs. max. dynamic displ.

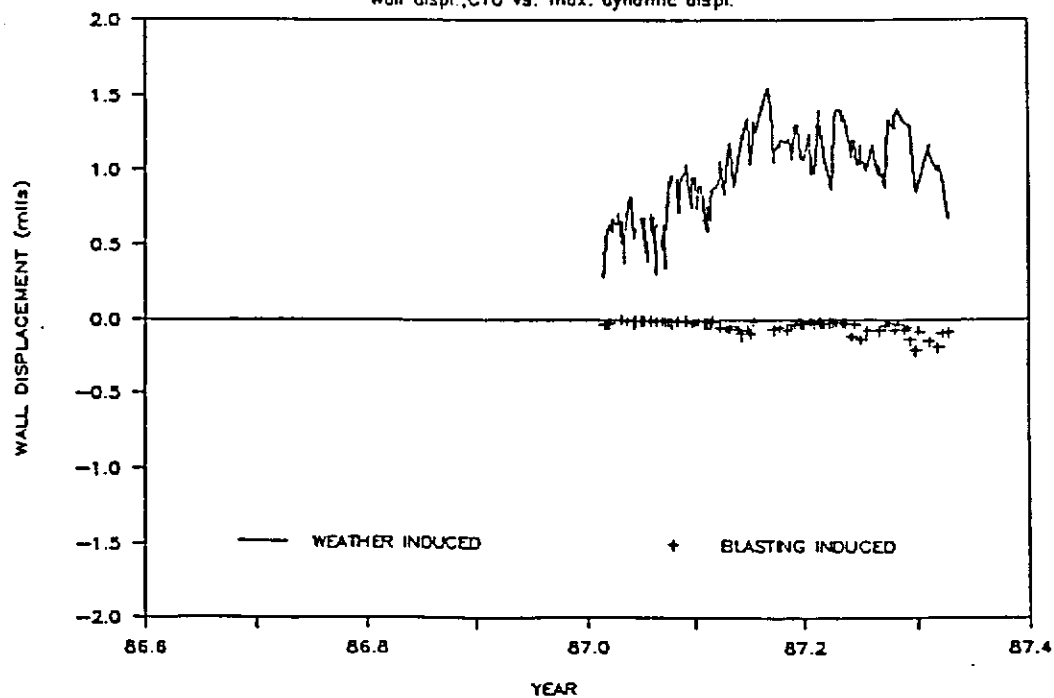

Weather vs. Blast Induced Wall Displ.

Wall displ., C7 vs. max. dynamic displ.

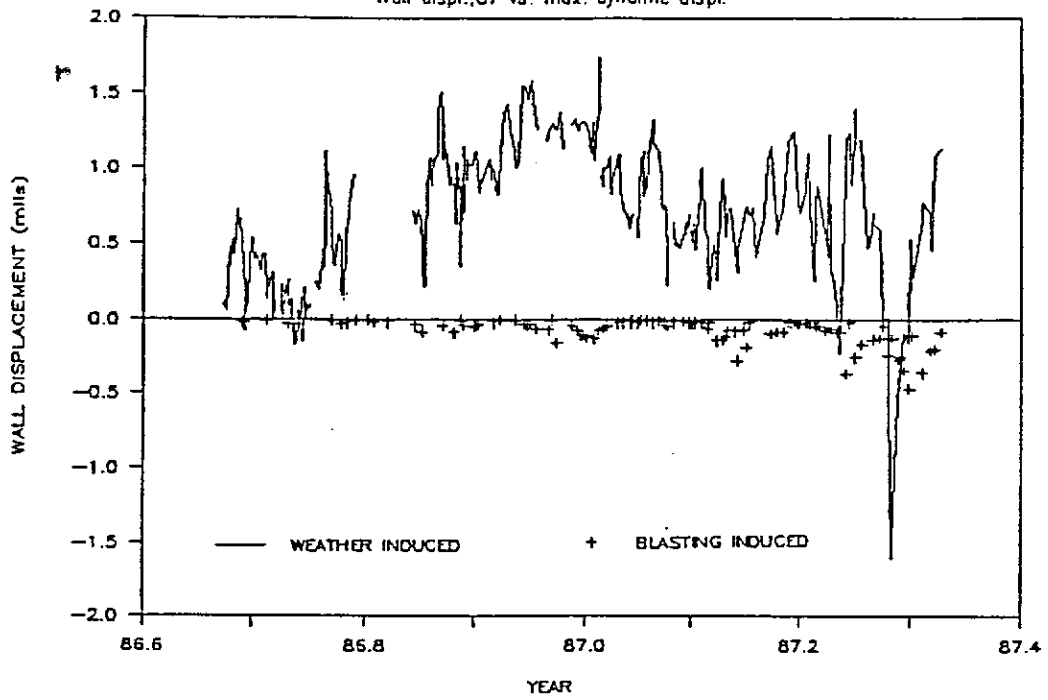

Weather vs. Blast Induced Wall Displ.

Wall displ., C8 vs. max. dynamic displ.

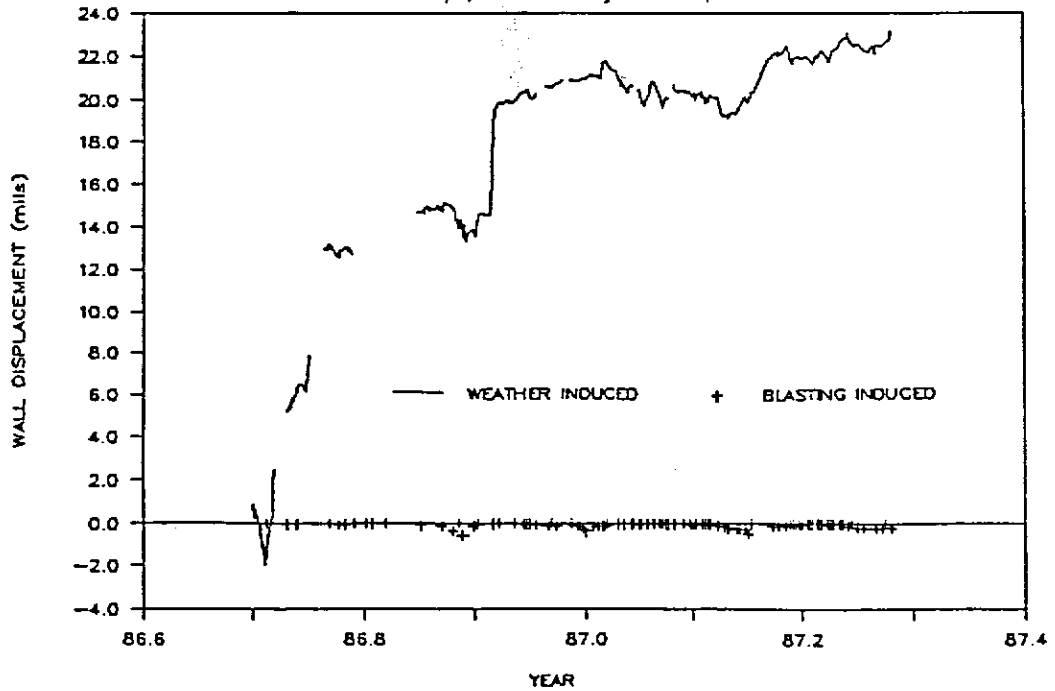

combined with observations of the weathering in response, described in Chapter 6, to find sensitive locations. Initially, two cracks and the middle of two drywall sheets were instrumented. The low response of the midsheet locations led to instrumentation of uncracked joints where their greater sensitivity was discovered.

For each of the positions, the environmental, static, or long-term displacements are plotted as a continuous line while the maximum displacement produced by any one blast is plotted as a single cross. This graphical difference represents the true time difference between the two phenomena. Environmental or long-term displacements occur gradually over time while blast induced displacement occurs only during the peak motion of a two second blast. The duration of blast induced peak motion and displacement is on the order of only 0.01 seconds, while a maximum, weather front induced displacement may last days or 200,000 seconds.

At all locations, except c7, the environmental or weather induced displacements were at least ten times that of the largest blast induced displacement. This conclusion parallels that made by the U. S. Bureau of Mines during their test house study (Stagg et al., 1983). Although all measurements were corrected for temperature effects, it could be argued that gauges on the outside walls may have been at different temperatures than the inside air used for the temperature correction. However, this observation is

not true for gauges on inside, first floor walls, locations c6 and c7. These walls would have been at equilibrium with the inside air, and gauges on them show the same large difference between weather and blast induced displacements. Location c7 is the most blast sensitive location; however, even at this location the maximum weather induced displacements are three times that of the maximum blast induced displacements.

Blast induced displacement mirrors environmental displacement for the eight positions that were monitored for periods of three months or more. Where the environmental response was high, so was the blast response. This sensitivity and the similarity of environmental and blast response is usually explainable. For instance, c7 spans a crack over a doorway in a wall that carries load from the second story. Furthermore, the crack is located at a joint between two drywall sheets exactly at the door corner. All these factors lead to high stress concentration (opening in a load bearing wall and location at a square corner) and low stiffness (joint between two sheets). Thus, any distortion of the house's structural system, produced by environmental changes or blasting, will tend to produce large displacements at this location. Location c10 is another example of a structural discontinuity. It too spans a joint between two drywall sheets; however, it is not near an opening but the joint is near and parallels the junction of the original middle section of the house and

the eastern addition. The difference in foundation conditions (shallow for the east and deep for the middle) and different roof framing will tend to produce differential displacement whenever the structure is distorted either environmentally or through blasting.

RESPONSE TIME HISTORIES FROM TYPICAL BLAST INDUCED GROUND MOTION

Figure 5-5 compares the response of the structure to the ground motion and air overpressure excitation from a typical blast during this study. As discussed in Chapter 4, 50% of the blasts detected during this study had ground motions less than 0.12 ips at the test house. Therefore, this blast, which produced transverse ground motions of 0.163 ips, is slightly more energetic than the average blast.

The fourteen channels of information, labeled on the left, can be divided into three main groups: the upper four are the three components of the ground motion and the air overpressure; the middle four ("d's") are the motion responses of walls (1 and 2) and superstructure (3 and 4); the lower six ("c's") are the displacement responses. The locations of these gauges on the house is shown in Figures 2-2 and 2-4. The ground and response motions are recorded as particle velocity in terms of inches per second, ips; the wall displacements are recorded in terms of mils (1/1000'th of an inch).

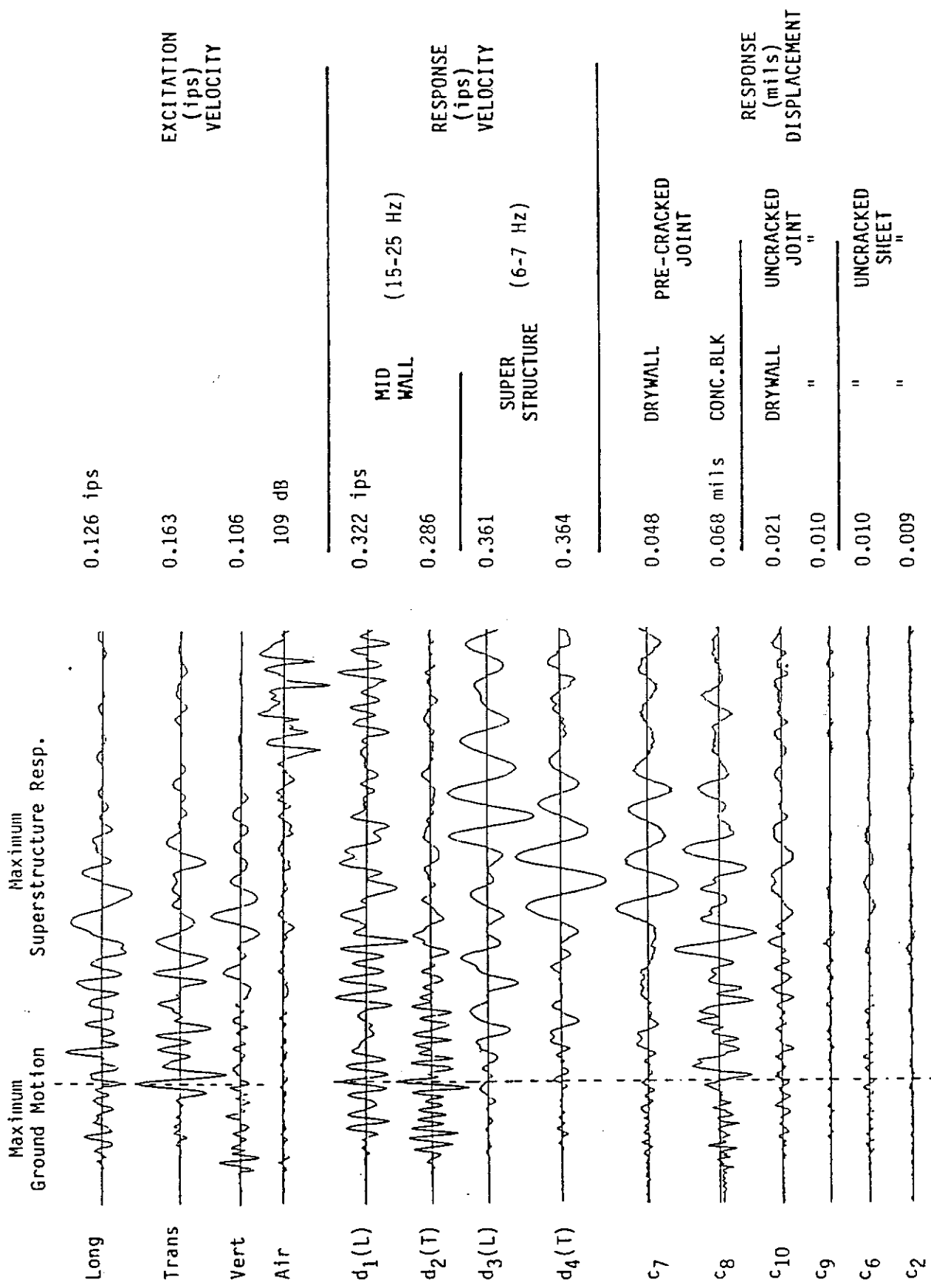

FIGURE 5-5

Time Histories of Test House Response to 0.163 ips Ground Motion

By comparing timing of the peaks in Figure 5-5, it can be seen that the initial, higher frequency, excitation produces the greatest wall velocity response (d1 and d2), while the trailing, lower frequency excitation produces the largest superstructure responses (d3 and d4). Wall deformations away from the second story (c10) are produced somewhat equally by the high and low frequency portions of the excitation. Those immediately below the second story (c7) are larger during the lower frequency motions. In phase response of c7 with d3 and d4 show the importance of the second story response.

Of special interest is the response of the outside wall (d1) to the overpressure air blast. During the arrival of the air overpressure, some 1.5 seconds after the ground motion due to its slower propagation velocity, the outside wall responds almost as much as it did to the ground motion. This wall response to air overpressure probably is a factor in complaints at great distances where ground motions are low but air overpressures may be high due to atmospheric conditions. While air blast response motions are not large enough to crack the exterior walls, they may be large enough to rattle dishes and/or bric-brac hung on the walls.

COMPARATIVE TIME HISTORIES FOR NATURAL ACTIVITIES

Response of the test house to thunder and door slam is shown in Figure 5-6. Thunder produced an air pressure of

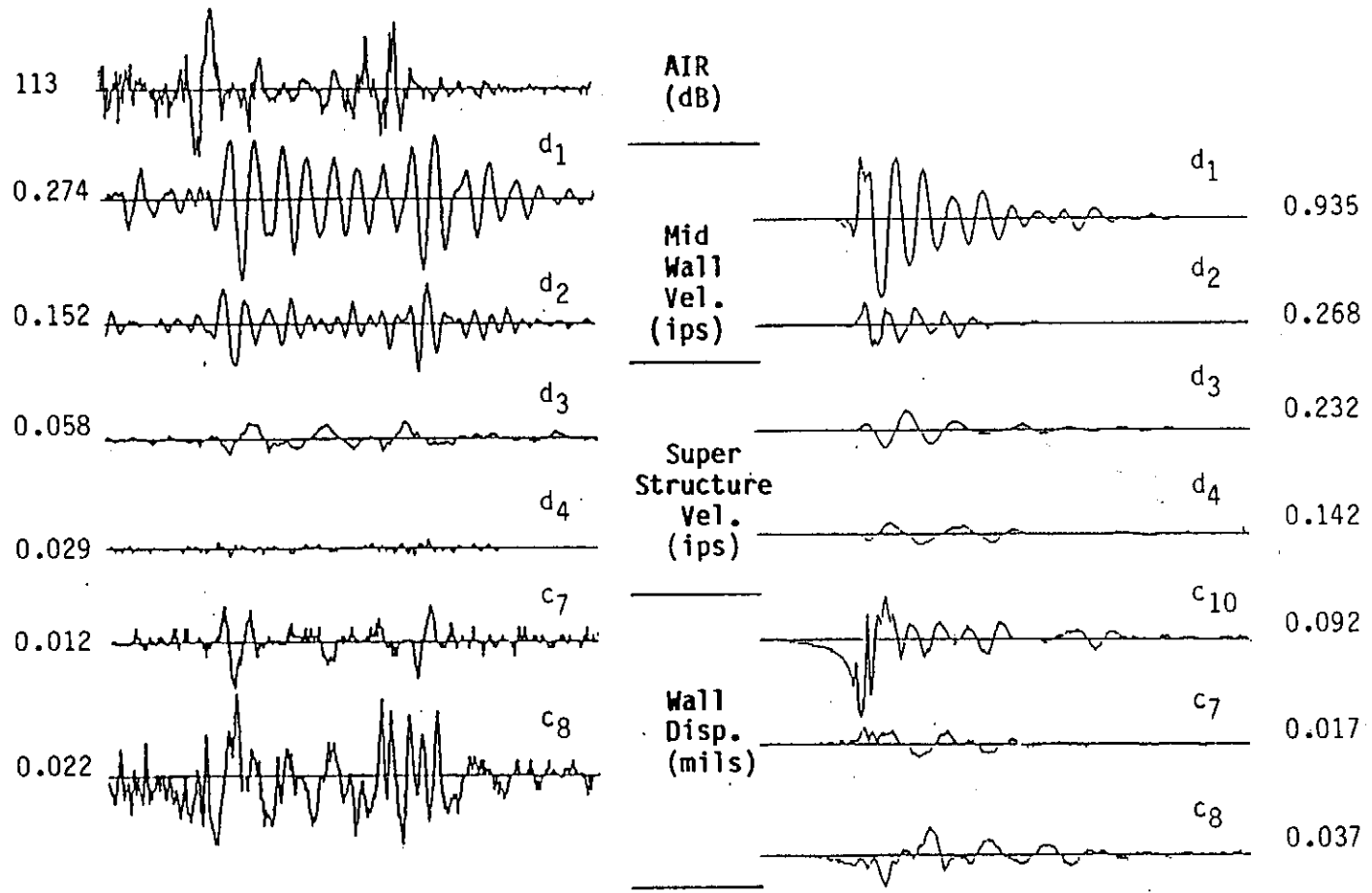

FIGURE 5-6

Response to Thunder (left) and Door Slam (right)

some 113 dB at 14 Hz and the exterior wall (d1) responded almost twice as much as the interior wall (d2). The upper story (d3), representing response of the superstructure, responded even less than the interior wall. Cracked wall sections (c7, drywall, and c8, concrete block) had the greatest displacement response, 0.012 and 0.022 mils, respectively. All transducers had maximum response at the time of peaks in air pressure.

Response of the house to slamming of the front door is shown also in Figure 5-6. Trends similar to those for the air blast are observed and it appears that a front door slam produces a large pressure difference that drives the wall some thirty feet away with transducers d1 and c10. Vibratory motions on a wall immediately adjacent to the door would be larger as shown in Table 3 from the USBM test house (Stagg et al, 1983).

COMPARISON OF ENVIRONMENTAL, NATURAL ACTIVITY, AND BLAST INDUCED DISPLACEMENTS.

Wall displacements produced by weather effects are compared in Table 5-1 with those produced by the 0.16 ips blast and other transitory motions described above. Passage of a weather front produces wall deformations that are ten to twenty times greater than those produced by this 0.16 ips surface coal mine blast. The representative nature of the September and January fronts has been discussed in Chapter 3. This large difference between

TABLE 5-1

COMPARISON OF STRAIN LEVELS INDUCED BY
ENVIRONMENTAL EFFECTS AND SURFACE MINE GROUND MOTIONS

Loading Phenomena	Transducer Location*	Wall Displacement (mils) (1 mil=0.001 in.)	Event Date/Time
Thunder/Lightning	c8	0.022	09/20/86
	c7	0.012	04:59:02
	c6	0.009	
Hard Door Slam (30 feet or more from transducers)	c8	0.035	01/13/87
	c7	0.017	13:07:32
	c9	0.023	
	c10	0.092	
	c6	0.017	
Blast L 0.13 ips 15 Hz T 0.16 ips 16 Hz V 0.11 ips 8 Hz	c8	0.068	01/08/87
	c7	0.048	08:51:59
	c9	0.010	
	c10	0.021	
	c2	0.009	
	c6	0.010	
Weekly Env. Change (passage of weather front)	c8	1.130	09/12/86
	c7	0.550	(week of)
	c6	0.202	"
	c2	0.111	"
	c9	0.500	01/16/87
	c10	0.400	(week of)

*Wall condition at transducer

- uncracked drywall joint, exterior wall - c9 c10
 panel, interior wall - c6
 exterior wall - c2
- cracked drywall joint, interior wall - c7
- concrete block joint, basement wall - c8

weather and blast induced wall deformation confirms the observation made at the USBM test house.

Thus, approximately once a week a house is subjected naturally (by changes in the weather) to deformations that exceed by many times typical blast induced motions. It also appears that an energetic door slam may produce deformations on the other side of the house more than 50% of those produced by a typical blast. As found in the USBM test house, door slamming on the same wall as the gauge produced strains or displacements five times those of a typical blast.

VISUAL CRACK OBSERVATION

An orderly process of crack observation is as important as the measurement of wall motions and deformation that is automatically accomplished through the Tele-Blast system. The procedure must allow distinction between environmental and single event blast induced cracking. Such distinction is possible only with visual inspection of critical wall surfaces immediately before and immediately after a blast. This inspection must be conducted for each significant increase in ground motion at the test house.

The pre-blast inspection is necessary to isolate any possible environmentally induced cracks that may have developed between crack inspections. Since threshold blast cracks are similar to those caused by the normal aging process (Stagg, et al., 1983), it is important that the two types of cracks not be confused. If an environmental crack had appeared between inspections, the pre-blast inspection would so identify it and exclude it from cracking attributable to the specific blast in question.

SIGNIFICANT CRACK

Cracking is identified by the appearance of new cracks or the extension of existing cracks. However, changes in

crack width is not employed as a measure of significance. While changes in the cracking rate can be determined from data observed with this procedure, the emphasis in this work is the identification of those cracks attributable to the specific blasts that are inspected.

In order for a new crack or an extension to be significant, it must lengthen by 1/2 inch during the blast. In other words, it must lengthen between the immediate pre- and post-blast inspections. Immediacy is an important characteristic of blast induced cracks, as they can only be produced by the dynamic wall displacements that occur only during the blast.

RECORDING METHOD

Some 500 square feet of surface on seven different walls constructed of four different materials were inspected visually. Only specific walls were inspected to concentrate effort on key areas.

Inspections were conducted within established grid boundaries to ensure uniform and consistent coverage. Observations were recorded on grid sheets that contain the initial observations. An example of an initial grid sheet is shown in Figure 6-1. The same sheet was employed for succeeding pre- and post-blast inspections. Only changes were added.

Even with observation limited to seven sections, thorough inspection still required some four hours. The

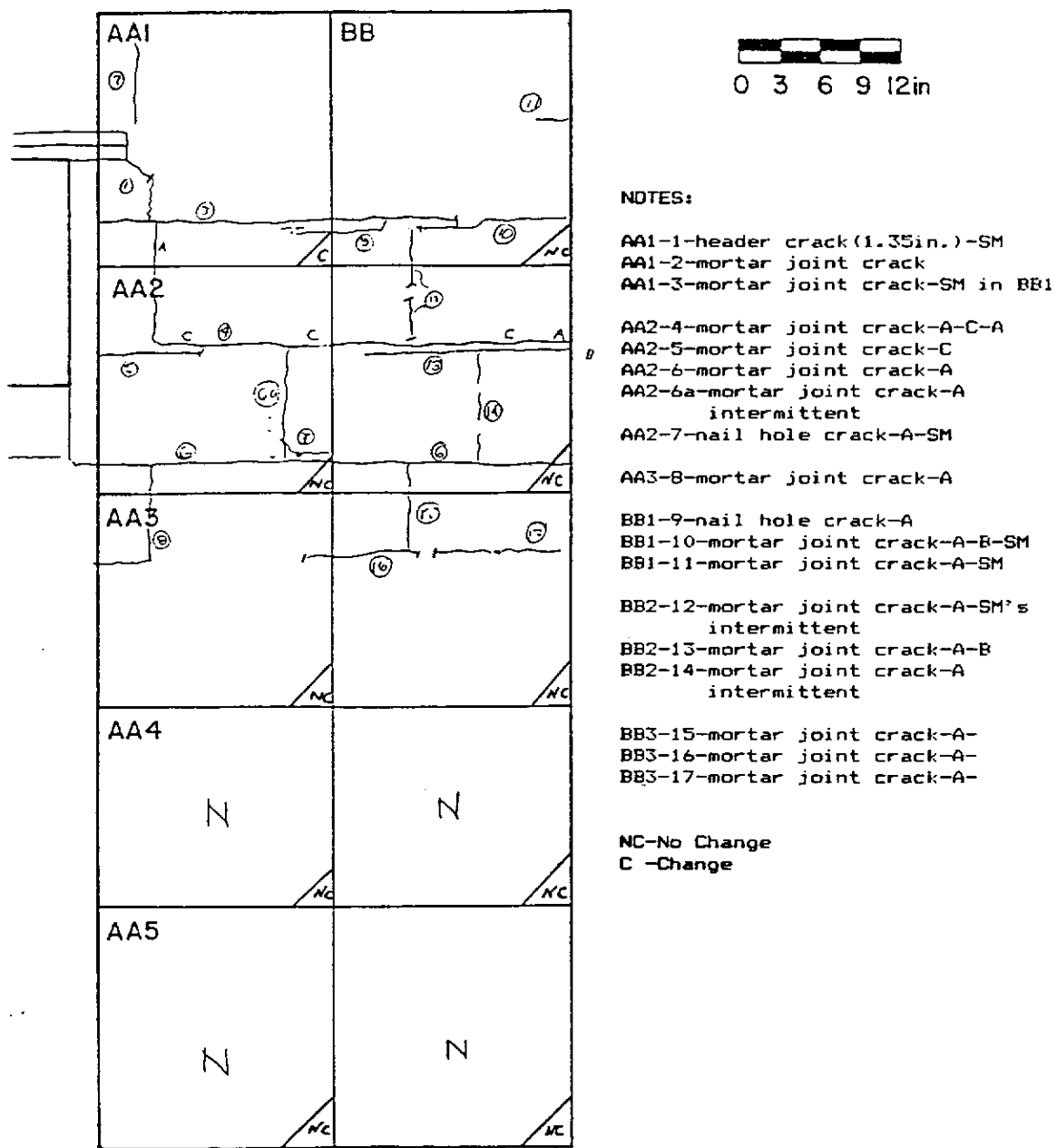

FIGURE 6-1

EXAMPLE GRID SHEET
CENTER WEST WALL OF WEST BASEMENT

observation was always conducted by the same person, S.W. Lucole, under uniform conditions to ensure a constancy of visual acuteness. The threshold of cracking for this study was a hairline fracture (just visible with the naked eye with corrected lenses) that is similar to that which forms from natural causes. Many times inspection with a magnifying glass was necessary as shown in Figure 6-2, to correctly observe environmentally induced crack extensions.

CHOICE OF WALLS AND WALL MATERIALS

The initial condition survey served as a guide for choosing the appropriate areas for observation. Exterior brick inspection was limited to the garage because of the continual failure of the separately founded brick veneer on the house. A detailed discussion of the veneer failure can be found in the Initial Condition report (Dowding and Lucole, 1985). As shown in Figure 2-4, two external brick sections were chosen, one a corner and the other at the middle of the west wall including a crack at a position with measured long-term foundation distortion.

Concrete block inspection was conducted at two sections on different walls in the basement of the western addition as shown in Figure 2-4. Both walls were heavily cracked and appeared to be weak points in the structure. Poured concrete was initially inspected at one section in the middle basement. However, efflorescing of the concrete had disrupted the paint to the extent that only major cracks

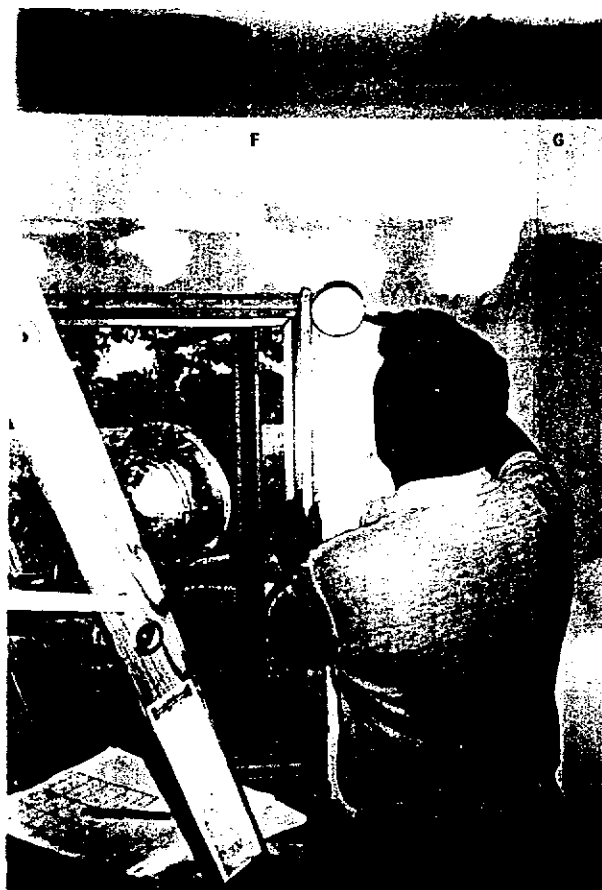

FIGURE 6-2

INSPECTION WITH SIDE LIGHTING TO BEST ILLUMINATE CRACKING

could be observed. None of these three locations represented an even moderately suitable condition for crack observation.

Gypsum wall board response was inspected on three walls in the living room of the ground floor as shown in Figure 2-4. This wall board had to be added because the room originally was panelled. The original twenty-four inch distance between wall studs (not typical of modern construction) was retained to model local conditions. This room was chosen for refinishing because it had the wall with the largest span, which also directly faced the mining operation.

LOCATION OF OBSERVATION SECTIONS

The seven inspection sections that incorporate some 500 square feet of the test house walls are shown in Figure 2-4 by the heavy black lines labeled with subscripted "s's". Three sections were chosen on the first floor, and included s3, and interior wall beneath the second story east wall, s2, the largest wall facing the mine, and s1, an eastern exterior wall. Two sections, s4 and s5, were chosen in the full depth western concrete block basement. Two sections were chosen on the garage's half-height brick facade; s6, in the middle of the long western wall and s7 at the southwestern corner. An eighth section in the original middle basement was initially mapped; however, efflorescing

paint and concrete prohibited accurate observation and the section was abandoned.

Major existing cracks in the concrete block or brick sections were instrumented with a mechanical crack gauge (shown in Figure I-7) to monitor displacements and support visual observation. The major horizontal crack in s4 was also instrumented with a computer monitored inductance gauge. The only drywall crack, above the doorway in s3, was monitored with a computer monitored inductance gauge.

WEATHERING IN AND INITIAL GAUGE PLACEMENT

Observation walls were monitored periodically for three months prior to beginning before/after observation in order to observe their response to curing and the weather. First floor drywall, which replaced panelling to have a plastered wall nearest the blasting, was still curing. As a result, hairline cracks appeared in the drying joint compound in corners and over nail head depressions during periods of very low level to no blasting. These minute joint compound cracks were also observed by the U.S. Bureau of Mines (Stagg et al., 1983). Since they are directly related to curing joint compound and did not pass the test of significance, they were not included in the final crack report.

Inspection of walls prior to before/after observation also provided useful information for the placement of the inductance gauges. Since only six were available, it was crucial to place them at locations that displayed the

potential for significant movement. During this weathering period, two cracks showed gradual movement during periods of no blasting. One was a cracked joint between two dry-wall sheets just above the doorway in s3, and the second was large horizontal mortar joint crack, in BB2, in Figure 6-1. Therefore, two gauges were moved from their initial location in the middle of a drywall sheet on s3, positions c4 and c5, to the doorway and basement, c7 and c8, respectively. Subsequent observation showed these two cracks to displace the most of all 10 positions.

OBSERVATION SUMMARY

Table 6-1 has been constructed to integrate measurement of environmental and blast response with the visual before/after inspection for significant cracks. Dates of observation are compared to maximum ground motions and crack displacement at c7 during the blast and the maxima in between visits.

During the period of before and after inspections, progressively larger ground motions of 0.30, 0.55, 0.44, and 0.76 ips were observed to have caused no new cracks or extensions of old cracks. Before/after inspections also revealed no new cracks at progressively increasing dynamic displacements at c7 of 0.035, 0.090, 0.118, 0.131, and 0.276 mils. Inspection was terminated due to a loss of funding without observing any cracking during before/after visits. The initial period of weathering in before full

TABLE 6-1

SUMMARY OF CRACK OBSERVATIONS

Pre Blast Inspection Date	Post Blast Inspection Date	Date of Highest Ground Motion	Max Ground Motion, ips	#7 Disp. mils	Frequency @ max Ground Motion, Hz	Remarks
05/30/86		06/27/86	no event	n.o.		
		07/14/86	0.09	n.o.		
07/21/86			0.16	n.o.		
08/22/86			no event	n.o.		
09/12/86			no event	n.o.		
09/26/86			no event	n.o.		
		10/11/86	no event	n.o.	16	
	10/14/86		0.20	0.035		
11/14/86	11/14/86		no event			no change
11/18/86	11/14/86	11/14/86	0.30	0.035	21	no change
11/21/86	11/18/86	11/18/86	0.55	0.090	23	no change
12/31/86	11/21/86	11/21/86	0.44	0.044	21	no change
01/03/87	01/02/87	01/01/87	0.74	0.118	21	no change
02/20/87	01/03/87	01/03/87	0.72	0.131	14	no change
02/21/87	02/20/87	02/20/87	0.39	0.079	18	no change
02/23/87	02/21/87	02/21/87	0.38	0.276	10	no change
	02/23/87	02/23/87	0.41	0.072	28	no change
	04/04/87		no event			last inspection

n.o. = not operational

operation of the instrumentation and before/after inspections included only low level ground motions that did not exceed 0.20 ips. This level is one-fourth that of 0.79 ips, the lowest level at which U.S. Bureau of Mines personnel observed cracking during before and after inspection. Bureau inspected homes included one that was 150 years old in a severely cracked condition.

The lack of blast induced cracks is not surprising in light of the relatively large ratio of weather or environmental displacements to blast or dynamic displacements. As discussed in Chapter 3 and quantified in Table 3-1, on the average every week the test house is subjected to weather induced displacements of 0.477 mils at c7 which are 1.5 times greater than the largest displacement (0.276 mils on 2/21/87) produced during before/after blast inspection. In fact, as shown in Figure 5-3 during January of 1987, weather changes produced a displacement of 1.6 mils of c7, some 5 times that induced by the 2/21/87 blast.

REFERENCES

- Dowding, C.H. (1988), "Raw Data for Blanford Test House", report prepared by Digital Vibration, Inc. for Peabody Coal Company.
- Dowding, C.H. (1985), **BLAST VIBRATION MONITORING AND CONTROL**, Prentice Hall Inc., Englewood Cliffs, NJ
- Dowding, C.H. and Lucole, S.W. (1985), "Initial Condition Survey of Blanford Test House", report prepared by Digital Vibration, Inc. for Peabody Coal Company.
- Stagg, M.S., Siskind, D.E., Stevens, M.G. Dowding, C.H. (1983), **EFFECTS OF REPEATED BLASTING ON A WOOD-FRAME HOUSE**, U.S. Bureau of Mines, Report of Investigations 8896.
- Siskind, D.E., Stagg, M.S., Kopp, J.W., and Dowding, C.H. (1980), **STRUCTURE RESPONSE AND DAMAGE PROUDCED BY GROUND VIBRATIONS FROM SURFACE BLASTING**, U.S. Bureau of Mines, Report of Investigations 8507.

TECHNICAL SPECIFICATIONS OF INSTRUMENTS**ENVIRONMENTAL INSTRUMENTATION****Temperature, Humidity, and Wind Velocity**

Outside temperature and humidity were continuously recorded on a paper strip chart by a Weathertronics HI-Q Hhyaro-thermograph system, Model 5022. Records were retrieved monthly for entry in the project's data base. The gauges were housed in a standard, white, louvered, weather station enclosure.

Wind velocity (both speed and direction) was also continuously recorded on a paper strip chart by a Weathertronics system (sensor and recorder Models 2132 & 3000Q14) and retrieved monthly. Variable wind speed and direction were recorded every two seconds. Transducers were mounted on the TV antenna, 15 feet above the top of the front door.

Inside temperature and humidity were continuously recorded with a second Qualimetrics system, with the same monthly record retrieval. The unit was located on the hearth of the fireplace as indicated by the black square near the middle of the ground floor in Figure 2-4.

Water Table

Changes in the elevation of the water table were monitored with observation wells constructed as shown in Figure I-1. Depth of the water below the ground surface was measured monthly with a measuring tape. The wells, excavated to rock, are 10 to 11 feet deep as the bedrock is shallow beneath the test house.

Soil Movement Anchor

Swelling/shrinkage of the foundation soil was measured with the anchor system shown in Figure I-2. This device allows the expansion/contraction between the bottom anchor and the upper pipe flange to be measured with a micrometer that has a resolution of 1/10,000th of an inch. As the soil between the anchor and the flange expands or contracts, the distance "a" on the drawing changes. This distance was recorded one to two times per month.

Two types of anchors were employed, a commercially available Borros point and a concrete dowel. Borros points are normally employed where rock is not near the surface. The first anchor was installed with a Borros point during the initial exploration of the site before it was determined that the bedrock was shallow around the test house. The last three were the dowel types which were simpler to install with shallow bedrock. Details of the exact elevations of the components are given in Table

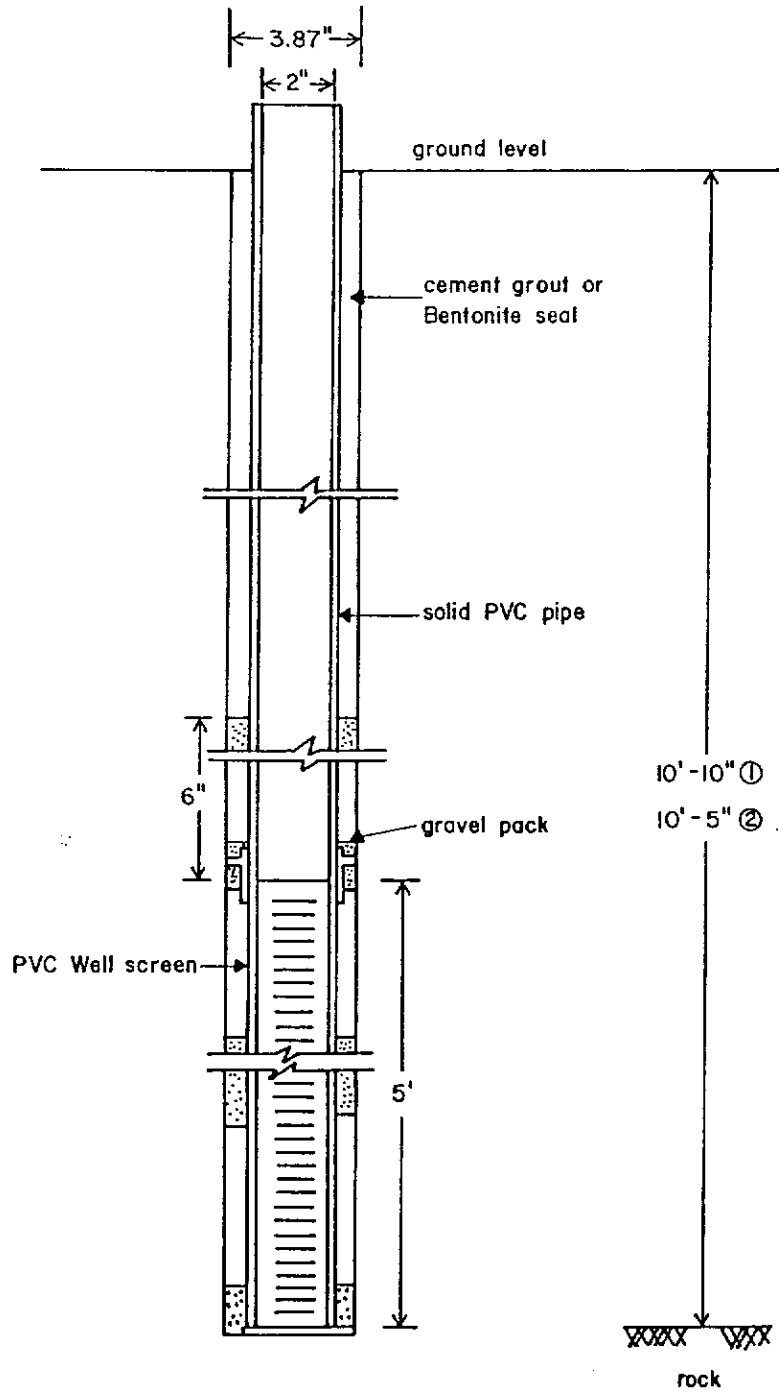

FIGURE I-1

WATER TABLE OBSERVATION WELLS

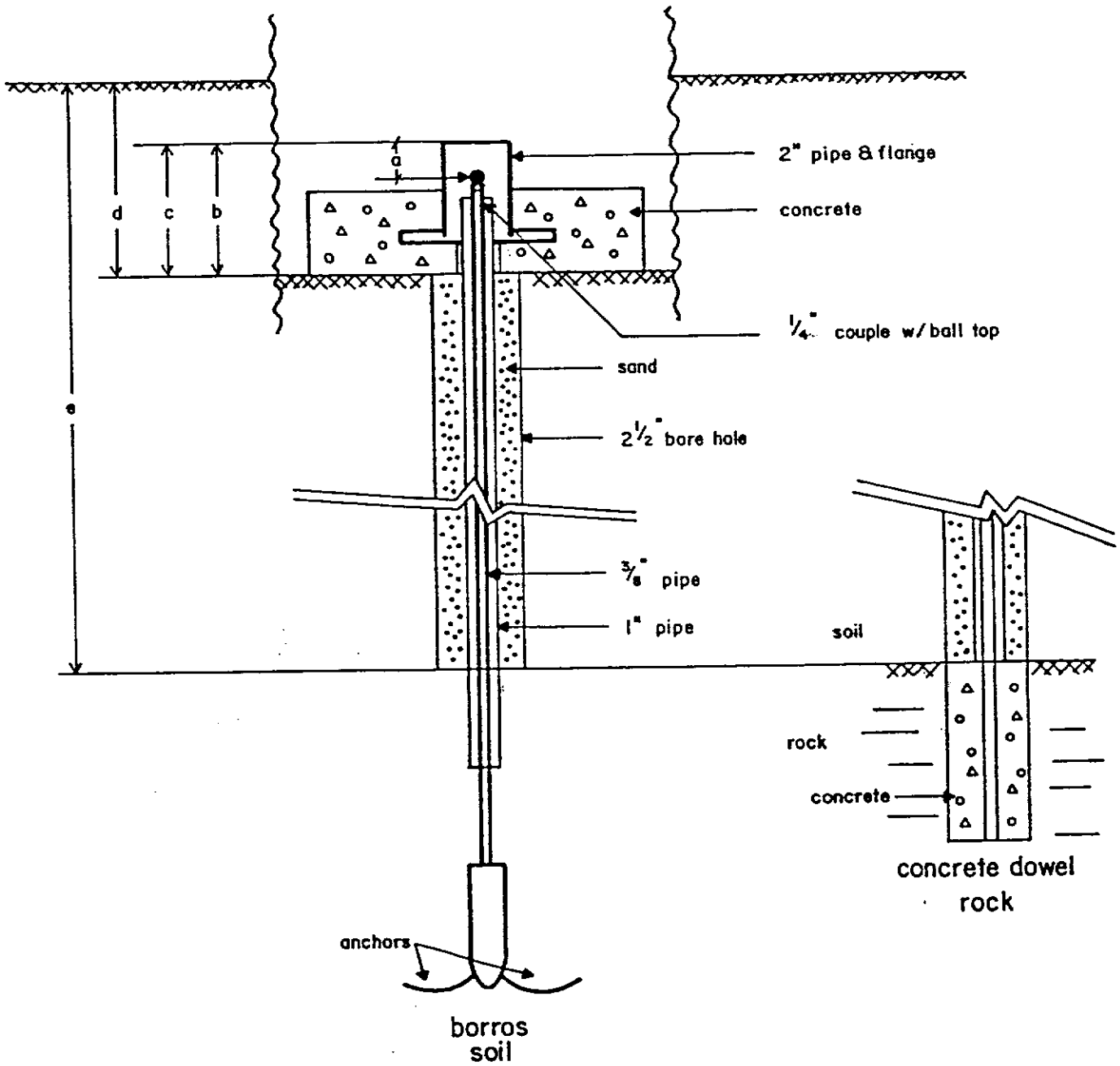

FIGURE I-2

SHRINKAGE AND SWELL MEASURING SYSTEM FOR ANCHORING IN SOIL OR ROCK
 (Dimensions are given in Table I-1)

I-1 with reference to the lettered dimensions in Figure I-2.

TABLE I-1 - ANCHOR GEOMETRY

Anchor	Dimensions on Figure I-2(in.)						Type	Tip Material
	a	b	c	d	e	f		
1	1	3	5.5	6	48	62	Borros Pt.	Soil
2	0.5	3	3	6	114	132*	Conc.Dowel	Rock
3	1.5	6	7	6	114	132	"	"
4	1.5	6	9	6	114	132	"	"

*NOTE: For concreted dowels, distance e minus distance f is the concreted depth of the dowel in the rock.

Surveyed Elevation Changes

Elevation changes were measured monthly with typical optical survey instruments. However, a machinist's scale was employed as the target to allow distinction of elevation differences as small as 1/1000th of a foot. Such high survey resolution was made possible by the nearby soil anchors which served as benchmark elevation references.

Three main types of elevation changes were measured. Those of the house structure itself and its garage, the separate brick veneer, and the concrete driveway. House structure movements were determined by elevation changes in the references (numbered 1-9 in Figure I-3) that are screwed into the frame of the house. Brick veneer move-

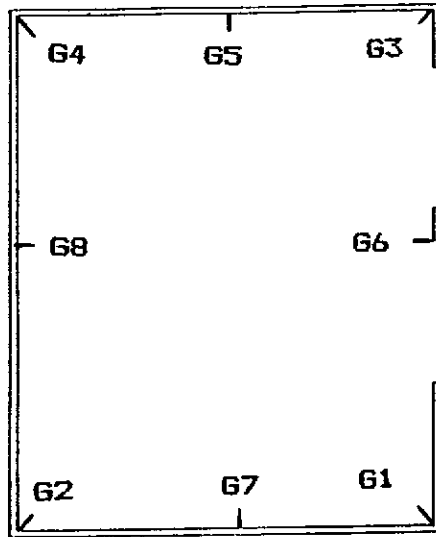

b.)
Garage

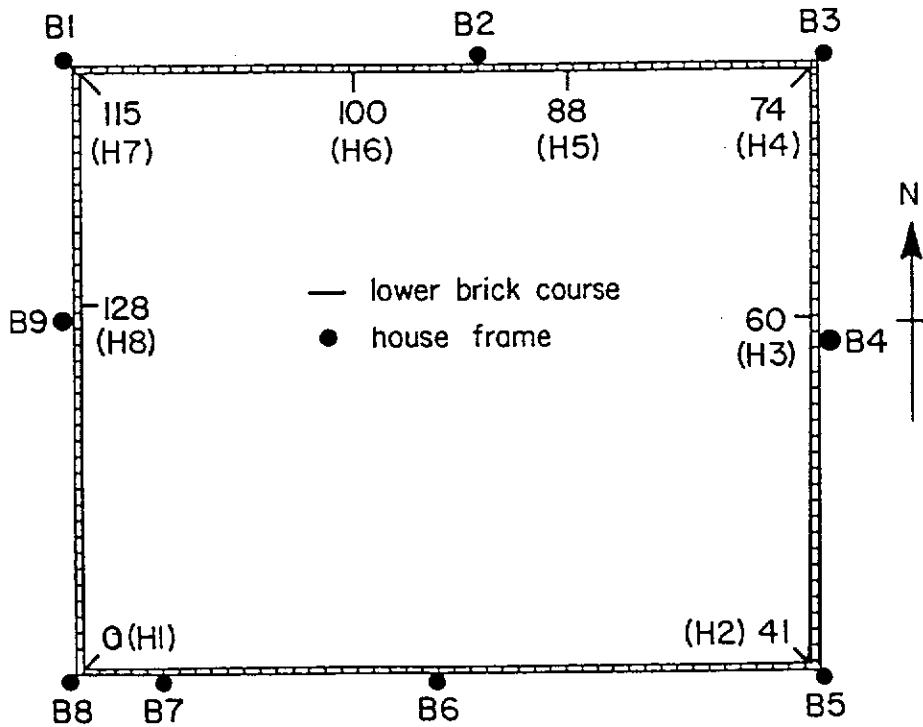

a.)
House

FIGURE I-3

LOCATION OF HOUSE AND GARAGE ELEVATION SURVEY POINTS

ments are determined by elevation changes of the lower brick course for both the house and the garage. The location of bricks on the lower course that were selected for surveying are also shown in Figure I-3. The house brick veneer was founded separately from the house frame and required the dual measurement system for the house. On the other hand, the garage brick veneer rests on the same foundation as the frame and changes in the elevation of its lower course was sufficient to describe changes in the frame as well. Locations for surveying elevation changes of the driveway sidewalk are shown in Figure I-4.

Ground Motion and Air Overpressure

Ground motion is sensed by transducers/geophones that measure particle velocity, the speed with which particles in the ground vibrate back and forth and/or up and down. The three transducers that are necessary to describe these motions are buried in the ground at the southwest corner of the house and are oriented in the vertical, horizontal north/south, and horizontal east/west directions.

Air overpressure that accompanies noise (thunder and blasting) is recorded by the pressure transducer located under the eave at the southwest corner of the house. This overpressure is that dynamic component above the atmospheric pressure at the time of the event.

Specifications for the velocity and air overpressure transducers are given in Table I-2 under Tele-Blast

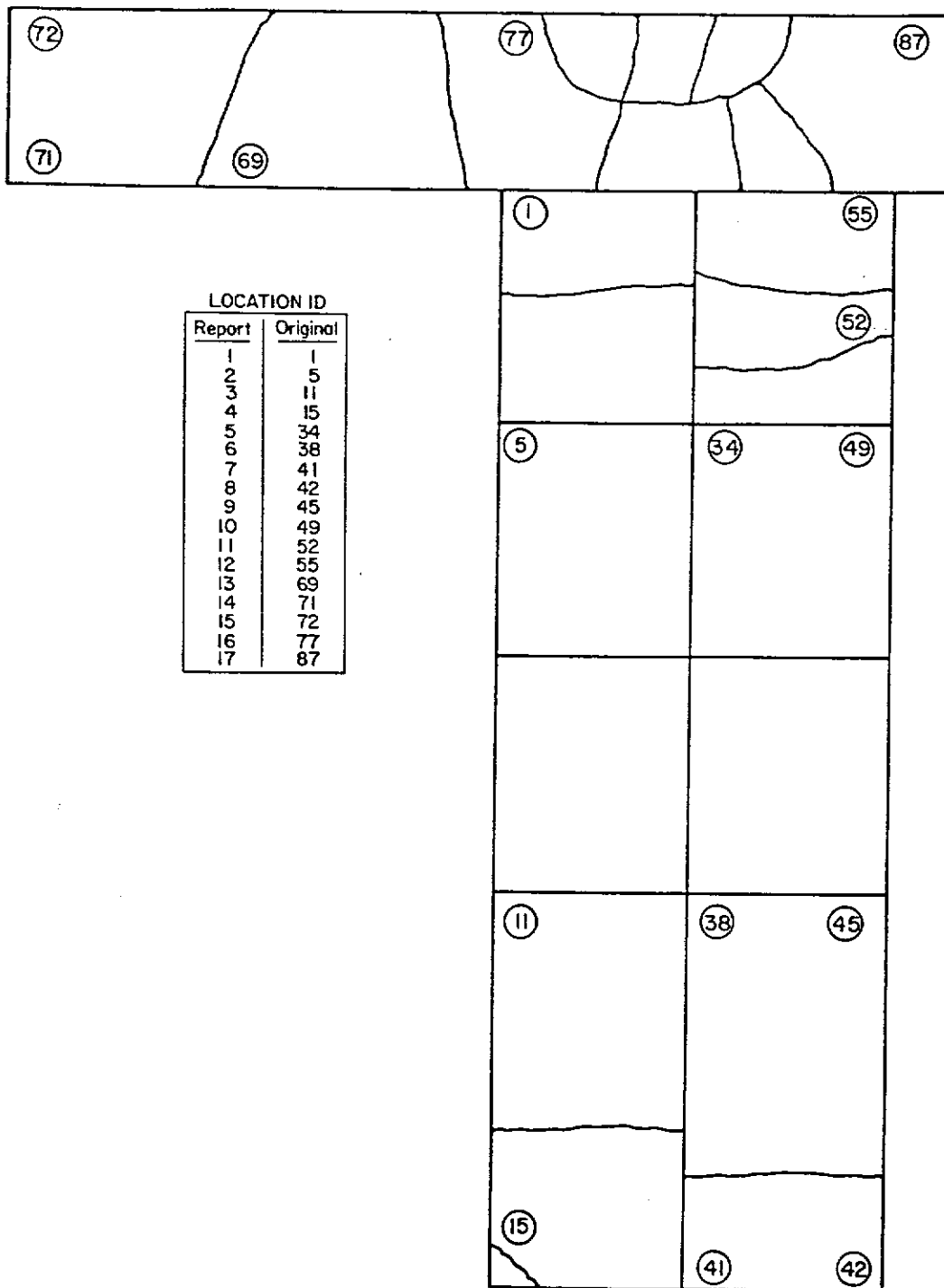

FIGURE I-4

LOCATION OF DRIVEWAY ELEVATION SURVEY POINTS

specifications. Dynamic events, such as thunder and blasting, require a special system for monitoring the output of the transducers. While they must be continuously monitored, only the transient, dynamic event information is of interest. Therefore, a special triggering system is required for the recording of significant information during the continuous monitoring. This information is recorded in the form of a digital time history by the Tele-Blast system for subsequent interpretation.

RESPONSE INSTRUMENTATION

Wall Velocity

The transducers employed to measure wall velocities are the same as those employed to measure the ground motions; their specifications are presented in Table I-2. As with the measurement of the excitation motions, these transducers are continuously monitored by the Tele-Blast system to record the significant transient event information.

Dynamic Crack/Wall Displacement

Dynamic wall displacement was measured with transducers that sense changes in the magnetic field caused by a non-magnetic target moving in and out of the field. As shown in Figure I-5b, the target's motion is detected by the sensor that ultimately sends a time history of the relative displacement between target and sensor to the

TABLE I-2

TELE-BLAST SYSTEM AND SPECIFICATIONS

CONCEPT

- * Continual monitoring of vibration and air blasts.
- * Initial analysis and storage of blast events in remote computer.
- * Immediate telephone access to data in remote computer by operator/regulator.
- * Daily acquisition of data by central computer.
- * Daily processing and report writing by central computer.
- * Third party storage of records.

BLAST REPORTS

- * Immediately available in your office via portable telephone terminal:
 - Peak particle velocity in each plane.
 - Frequency associated with peak motion in each plane.
 - Peak true vector sum.
 - Peak air blast pressure.
 - Location, machine number, date of calibration, event date and time, ownership,
- * Daily third party report - via mail:
 - Letter form of telephone report.
 - Time history of motion.
- *Optional Reports:
 - Monthly summaries.
 - Response spectrum analyses.
 - Fourier frequency analyses.

TELE-BLAST SPECIFICATIONS

- * Solid state - no moving parts.
- * Frequency range - particle velocity: 5 to 200 Hz.
- * Frequency range - air blasts: 6 to 200 Hz.
- * Velocity range: 0 to 2 inches per second (ips).
Other ranges factory set.
- * Air pressure range 100 to 140 dB - linear peak.
- * Digitizing rate: Factory set at 1000, 500, or 250 samples/second.
- * Length of record sampled: Factory set at 2 or 4 seconds.
Air blast separately recorded.
- * Continuous vibration monitoring.
- * Trigger threshold: Variable factory setting between 0.01 and 0.5 ips.
- * Recycle time: Immediate, upon completion of last event.
- * Power: 11.0 volts AC with stand-by battery for uninterrupted power.

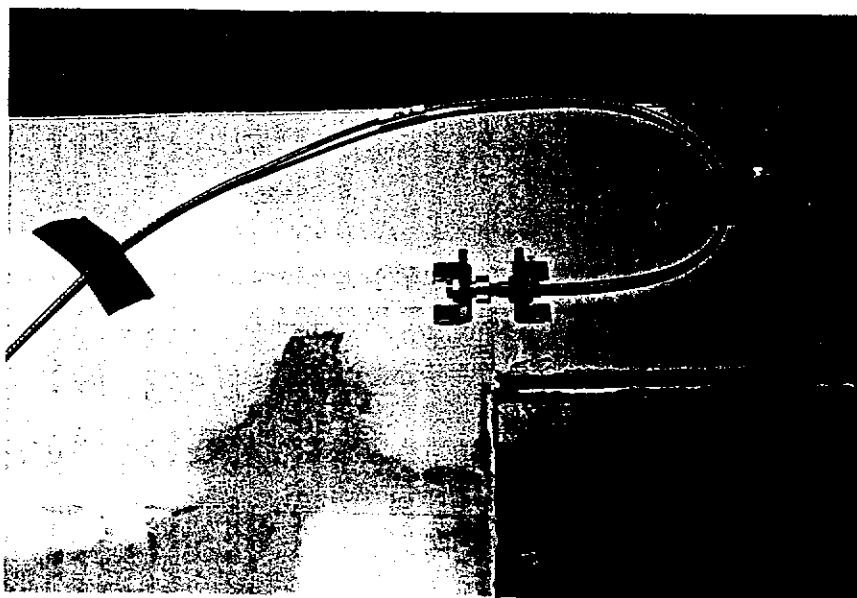

a.)

Combination of Kaman Sensor and Mount to Produce a Transducer That Measures Displacement Across a Known Distance

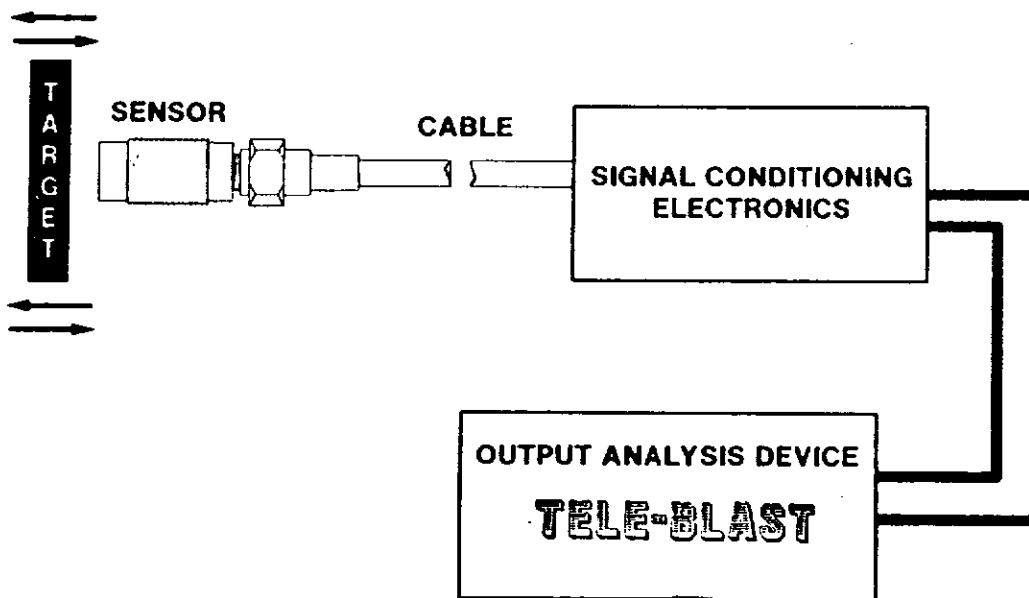

b.)

Linkage of Kaman Sensor and Signal conditioning with the TELE-BLAST System

FIGURE I-5

DYNAMIC CRACK DISPLACEMENT TRANSDUCER AND MEASUREMENT SYSTEM

Tele-Blast computer monitor. These dynamic displacements are continuously monitored and reported by the Tele-Blast on the same time base as the ground motion and wall velocity as shown in Figure 5-5.

The Kaman Instruments 4300 signal conditioner and 1U1 sensors that were employed for displacement monitoring have a reported resolution of 0.000004 in. Thus, the target and sensor, mounted on brackets separated by 0.62 inch as shown in Figure I-5a, can sense strains as small as

$$0.000004/0.62 = 6 \text{ micro in./in.}$$

The Kaman system was chosen over the more traditional strain gauges, as it can be employed to monitor both strains in uncracked materials as well as displacements of existing cracks and interfaces. For uncracked wall materials, the brackets shown in Figure I-5a can be mounted in any orientation on the surface of the material. To monitor crack movement, the brackets were oriented with the sensor target-axis perpendicular to a crack. In I-5a the transducer brackets would be oriented properly for a vertical crack.

The combination Kaman sensor, target, and mounting bracket was calibrated for temperature sensitivity; results of which are shown in Figure I-6. The solid line represents the output when an aluminum block, on which the sensor and brackets were mounted, is heated in an oven. Heating and cooling the aluminum block causes it to expand

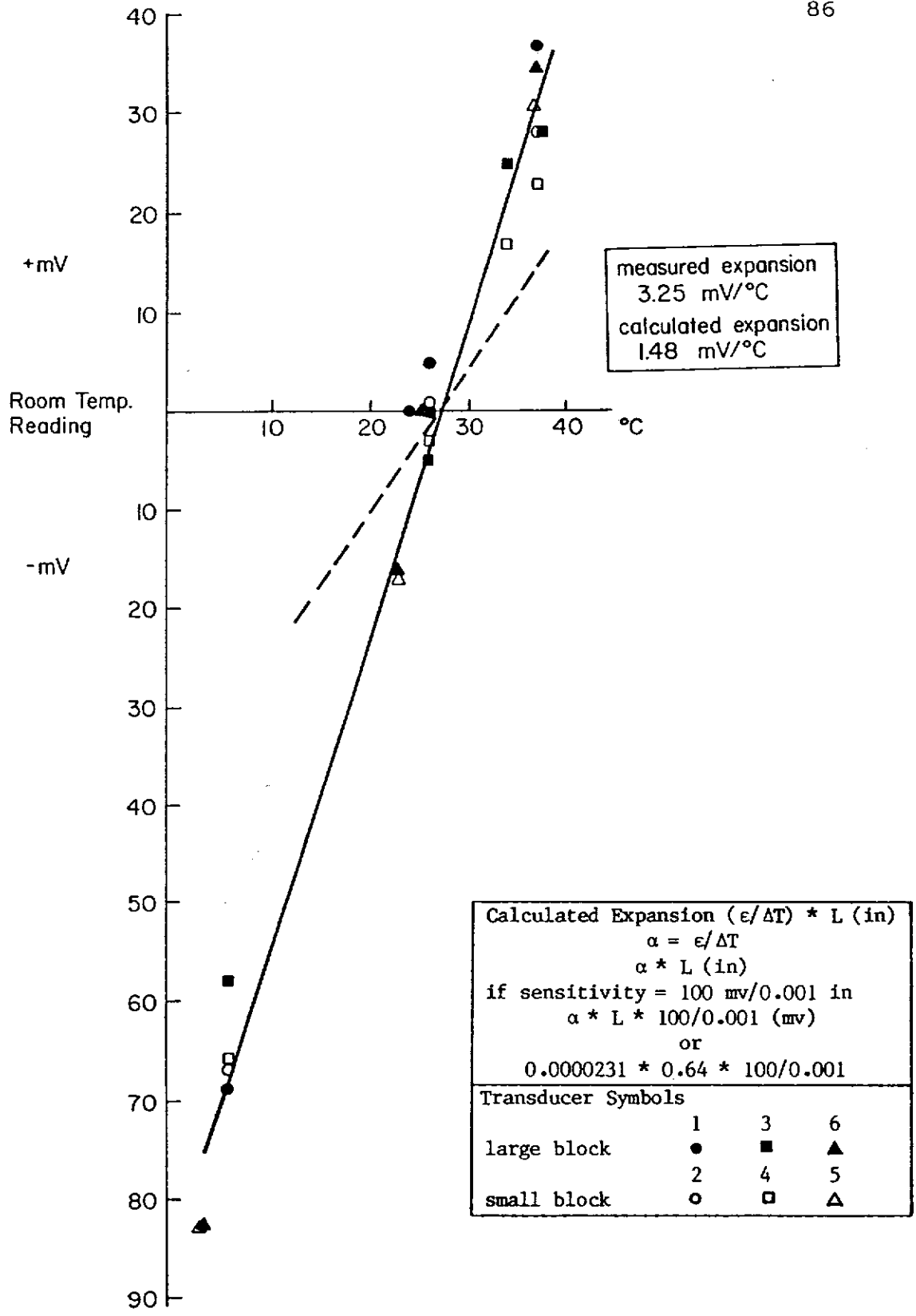

FIGURE I-6

TEMPERATURE CALIBRATION OF TRANSDUCERS SHOWS

(3.25-1.47=) 1.77×10^{-5} in/°C (1×10^{-5} in/°F OR 0.01 mil/°F)
CORRECTION IS NEEDED FOR SYSTEM

and contract, which changes the system output as the brackets are moved apart by the expanding aluminum. That expected output can be calculated from the thermal coefficient of expansion of the aluminum, separation of the brackets, and the response characteristics of the sensor; the results of which is shown as the dotted line in Figure I-6. The difference between the measured and calculated expansion/contraction results from temperature response of the brackets, which must be subtracted from the recorded output.

Static Crack Displacement

Static crack displacement was measured by a micrometer, shown in Figure I-7, with a resolution of 1/10,000'th of an inch. An illustration of the relationship between the measuring posts and the crack is shown in Figure I-7b. The change in crack opening was measured approximately every other week to monitor the long-term changes and to check and supplement long-term observations that were made with the Kaman, dynamic displacement transducers.

Tele-Blast Monitoring and Data Management System

The Tele-Blast concept is illustrated in Figure I-8 and outlined in Table I-2. A remote computer, "vibration monitor" in I-8a, records data that can be accessed through the telephone by either the mine operator, "immediate telephone report", or DVI for further

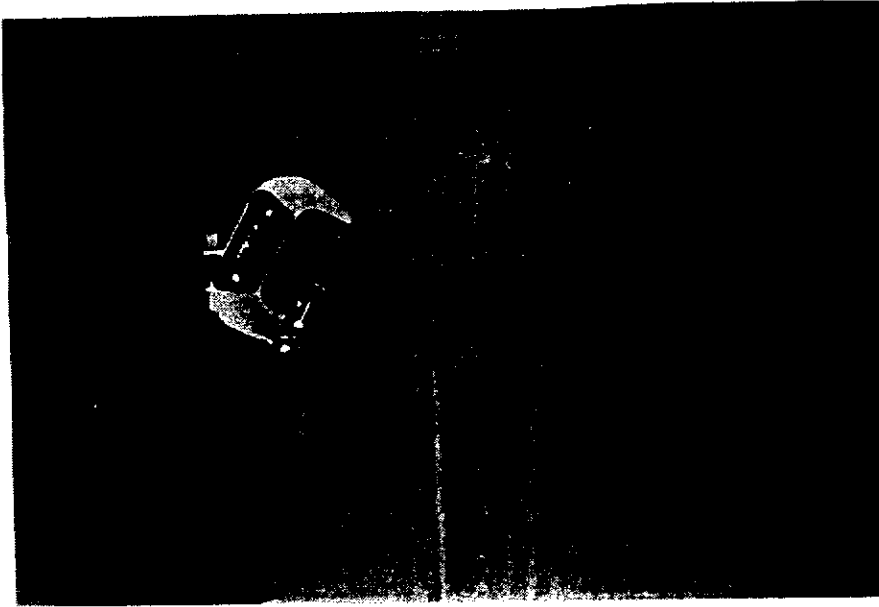

b.)
Use of Micrometer (0.0001 in.) to
Measure Distance Between Pegs

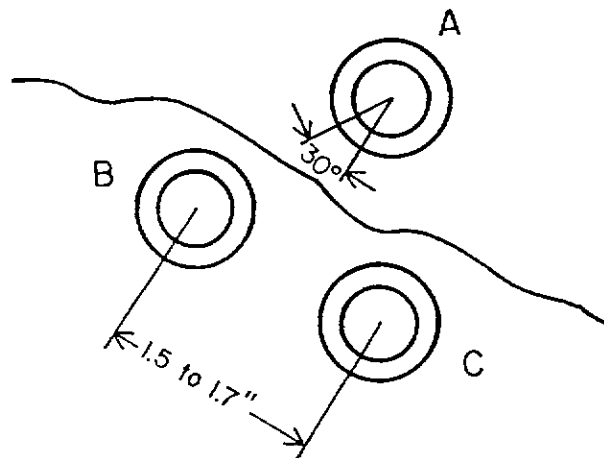

a.)
Dimensions of Static Crack Displacement Pegs

FIGURE I-7
COMPONENTS OF STATIC CRACK DISPLACEMENT SYSTEM

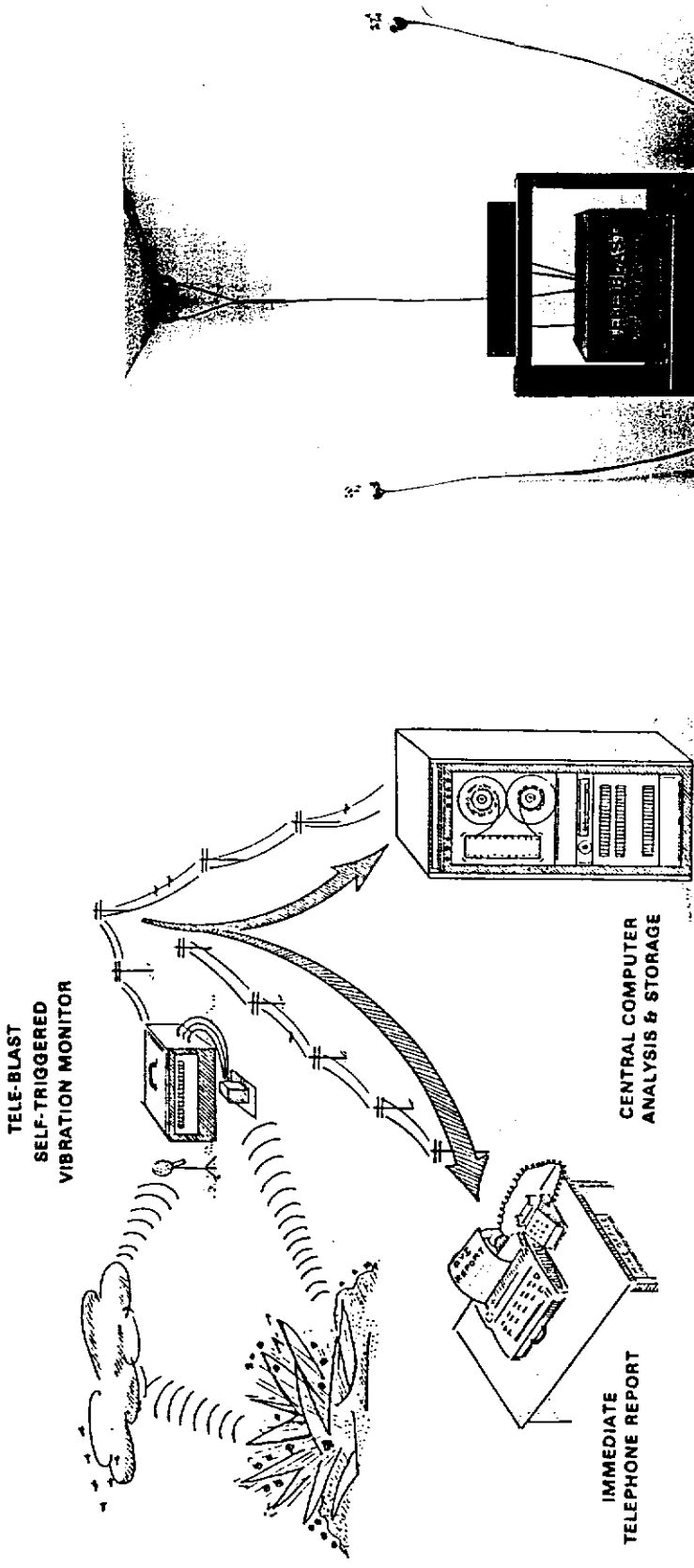

a.) TELE-BLAST Computer Provides Immediate Reports As Well As Remote Monitoring of House Response

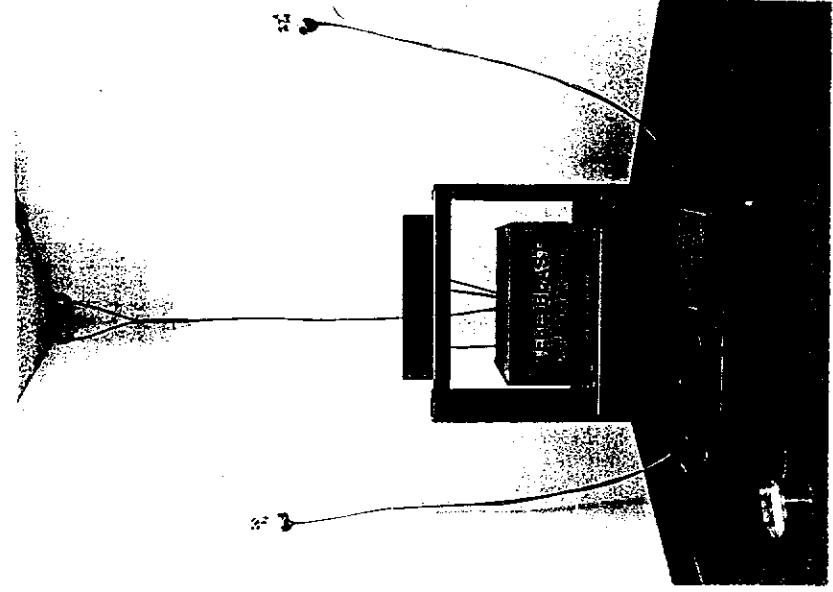

b.) TELE-BLAST System Processing Wall Response

FIGURE I-8

TELE-BLAST SYSTEM CONTINUOUSLY MONITORS WALL RESPONSE AND ALLOWS INSTANTANEOUS ON-SITE AND REMOTE ANALYSIS OF DATA

computerized analysis, "central computer". In addition to the instantaneous summaries of peak velocities and displacements with their associated frequencies available to the operator, time histories of all events were generated daily for DVI and PCC personnel. This is the only blast vibration monitoring system that allows such instant access to the full time history of ground motions and building response.

The concept has been further enhanced for this research project and now allows:

- Continuous monitoring of fourteen channels
- Common time base for all channels
- Capacity of eight (14 channel) events
- Automated telephone polling
- Triggering off: ground motion and/or structure response
- Immediate response spectrum analysis
- Immediate Fourier frequency analysis

The complete system with fourteen transducers is shown in Figure I-8b. The mine operator's terminal is on the bottom shelf, Tele-Blast computer on the middle shelf, Kaman signal conditioner on the top. The ground motion transducer package and air overpressure transducer are on the floor. The four wall velocity transducers are on the wall (two in the upper corner and two at the mid wall) along with the six displacement transducers (three at each mid wall position).